



Marion County Board of Adjustment Meeting Agenda

Monday, September 9, 2024

2:00 PM

**Growth Services Building -
Training Room**

Call to Order and Roll Call

Invocation and Pledge of Allegiance

Explanation of Procedure for Hearing Variance Requests

- 1. Acknowledgment of Proof of Publication, Mailing and Posting of Notice**
- 2. Consider the following Variance Requests**
 - 2.1.** [240803V - Gantner Family Trust: Roger D. and Noelene W. Gantner, Trustees, Request Variance, to Reduce Front Setback from 75' to 27' Feet for a Proposed Covered Porch Addition to an Existing Deck, in a Single-Family Dwelling \(R-1\) and Multiple Family Dwelling \(R-3\) Zone, Parcel Account Number 49167-004-00, Site Address 13584 S Highway 25, East Lake Weir, FL 32133](#)
 - 2.2.** [240805V - Brian and Tamra S. Ahl, Requests Variance, to Reduce the Front Setback from 25' to 19' for Proposed Additional Carport, in a One-and Two-Family Dwelling \(R-2\) zone, on Parcel Account Number 35322-004-04, Site Address 10030 SW 91st Terrace, Ocala, FL 34481](#)
- 3. Other Business**
 - 3.1.** [Update from County Attorney on Shed Permitting](#)
- 4. Consider the Minutes of Previous Meeting**
 - 4.1.** [July 1, 2024](#)

Adjourn



Marion County Board of Adjustment

Agenda Item

File No.: 2024-16357

Agenda Date: 9/9/2024

Agenda No.: 2.1.

SUBJECT:

240803V - Gantner Family Trust: Roger D. and Noelene W. Gantner, Trustees, Request Variance, to Reduce Front Setback from 75' to 27' Feet for a Proposed Covered Porch Addition to an Existing Deck, in a Single-Family Dwelling (R-1) and Multiple Family Dwelling (R-3) Zone, Parcel Account Number 49167-004-00, Site Address 13584 S Highway 25, East Lake Weir, FL 32133

DESCRIPTION/BACKGROUND:

Roger & Noelene Gantner, property owners, have filed a request for a variance from Land Development Code (LDC) Section 5.2.4. Environmentally Sensitive Overlay Zone (ESOZ). Development Standards The applicants are requesting a setback reduction from 75' to 27' on the westerly property boundary to allow a 4' addition to an existing deck and to also add a proposed porch cover over the same deck. The subject property is located within Unrecorded Lake Weir Landing Subdivision.



**Marion County
Board of County Commissioners**

Growth Services

2710 E. Silver Springs Blvd.
Ocala, FL 34470
Phone: 352-438-2600
Fax: 352-438-2601

**ZONING SECTION STAFF REPORT
August 5, 2024 moved to Sept. 9, 2024
BOARD OF ADJUSTMENT PUBLIC HEARING**

Case Number	240803V
CDP-AR	31565
Type of Case	Variance to allow for an ESOZ reduction of the front (lakeside) setback along the westerly boundary from 75' to 27' to add 4' to an existing deck and add a proposed porch cover over the same deck.
Owner	Gantner Family Trust: Roger Gantner Tr, Noelene Gantner Tr
Applicant	Gantner Family Trust: Roger Gantner Tr, Noelene Gantner Tr
Street Address	13584 S. Hwy 25 East Lake Weir, FL, 32133
Parcel Number	49167-004-00
Property Size	3.13 acres
Future Land Use	Rural Land Use (RL)
Zoning Classification	Multiple-Family Dwelling (R-3) – 1.7 acres closest to lake; Single-Family Dwelling (R-1) – 1.43 acres closest to S. Hwy 25.
Overlay Zone/Scenic Area	Environmentally Sensitive Overlay Zone (ESOZ) Secondary Springs Protection Zone (SSPZ)
Project Planner	Cindy Gaughf, Planning Tech II
Related Case(s)	060801V ESOZ @ 58' for SFR addition – approved 070502V ESOZ @ 60' for porch addition - approved 110602V ESOZ @ 30' convert deck to room addition – approved 200701V ESOZ @ 47' for mother-in-law suite & a pool - approved

I. ITEM SUMMARY

Roger & Noelene Gantner, property owners, have filed a request for a variance from Land Development Code (LDC) Section 5.2.4.(A) ESOZ. Development Standards. The applicants are requesting a setback reduction from 75' to 27' on the westerly property boundary to allow a 4' addition to an existing deck and to also add a proposed porch cover over the same deck (Attachment A). The subject property is located within Unrecorded Lake Weir Landing Subdivision.

**FIGURE 1
GENERAL LOCATION MAP**

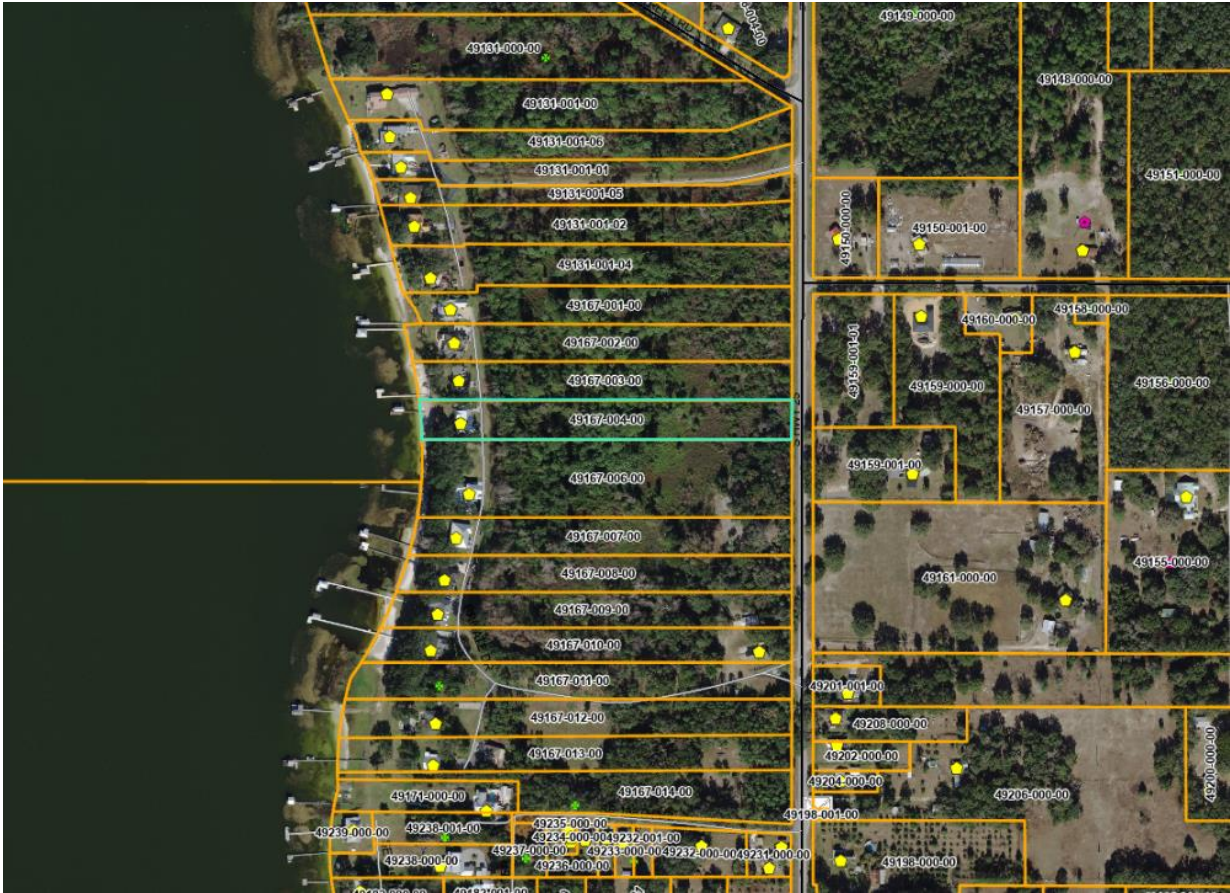

II. PUBLIC NOTICE

Notice of the public hearing was mailed to eight (8) property owners within 300 feet of the subject property on August 23rd, 2024. A public notice sign was posted on the subject property on August 22, 2024 (see Attachment B). Notice of the public hearing was published in the Star Banner on August 26th, 2024. Evidence of the public notice requirements is on file with the Growth Services Department and is incorporated herein by reference.

III. PROPERTY CHARACTERISTICS

The subject 3.13-acre property is located within the Rural Density (RL) Future Land Use Map Series (FLUMS) with Multiple-Family Dwelling (R-3) zoning and Single-Family Residential (R-1) zoning. The residence and deck are located within the R-3 portion of the property. The subject property consists of Lot 4 within the Lake Weir Landing UNR Subdivision. The aerial shows in Figure 1 that this rectangular-shaped property has 122' frontage along Lake Weir (Attachment C).

**FIGURE 2
SURVEY**

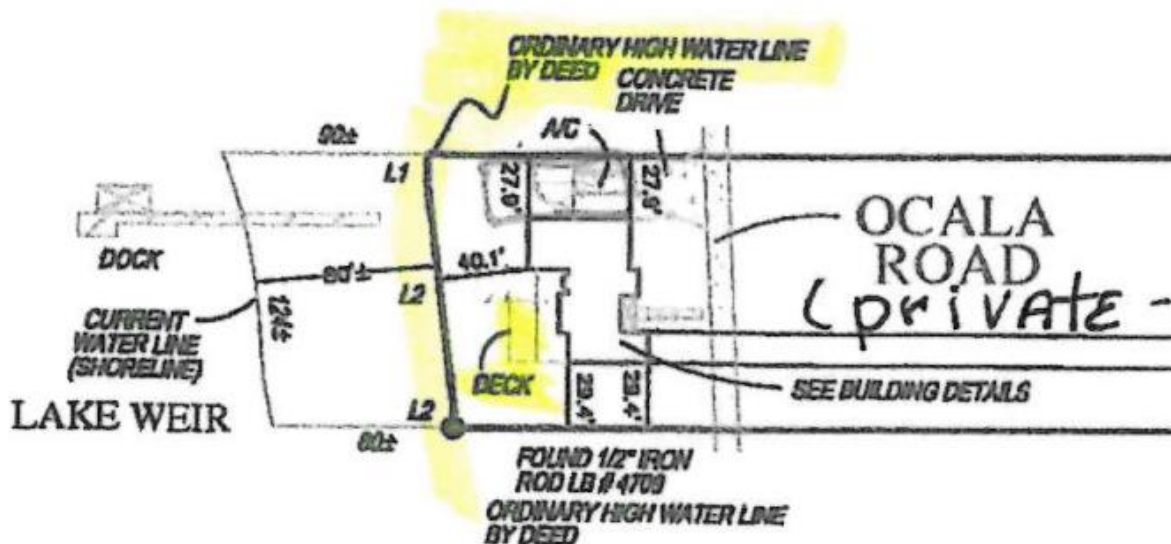
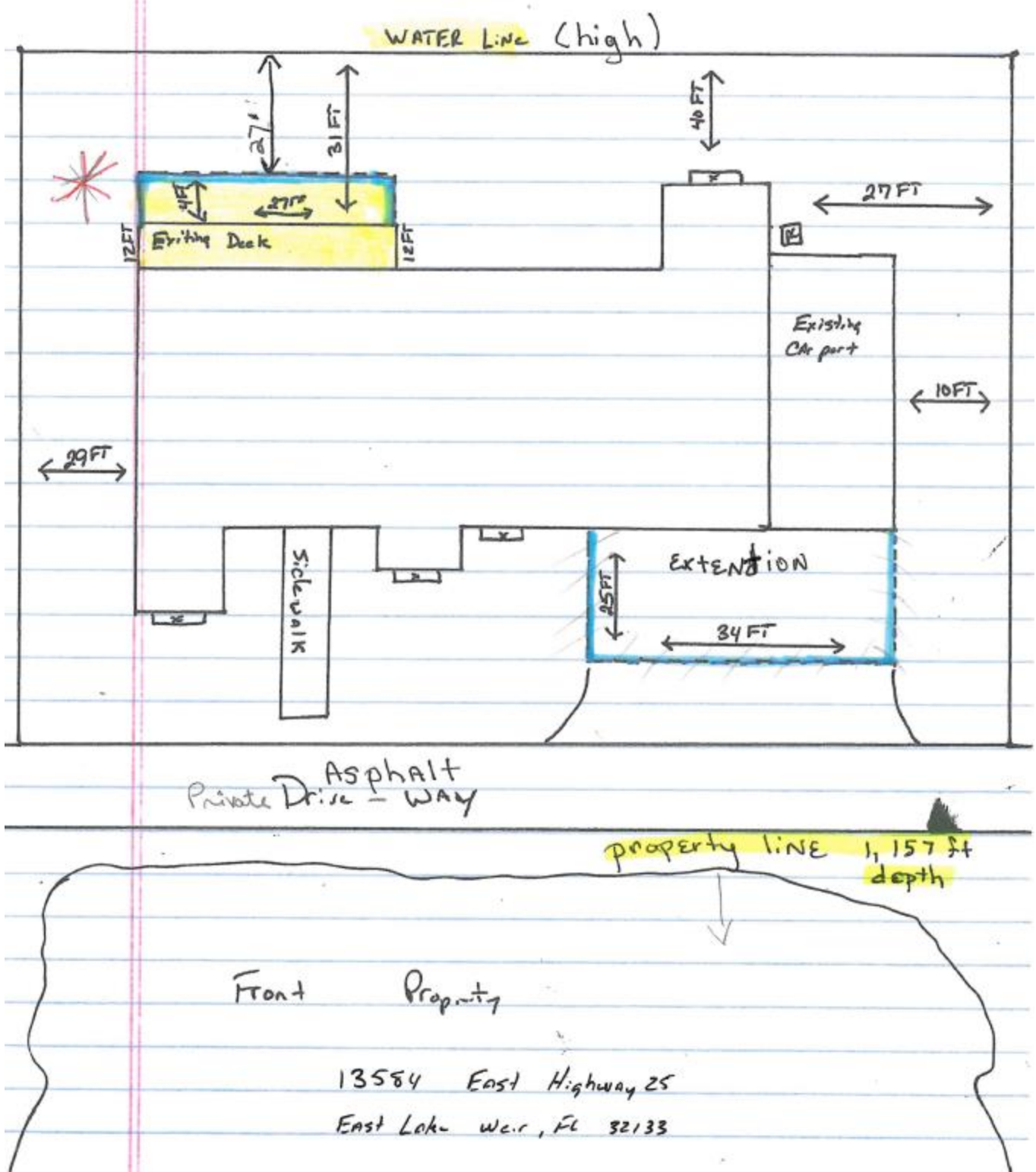

FIGURE 3
SITE PLAN



III. REQUEST STATEMENT

The applicant requests a variance from Land Development Code (LDC) Section 5.2.4.(A) ESOZ Design Standards. The applicants are requesting a setback reduction from 75' to 27' on the westerly property boundary to allow a 4' addition to an existing deck and also add a proposed porch cover over the same deck as shown in the site plan above in Figure 3 (Attachment D).

IV. ANALYSIS

LDC Section 2.9.2.E provides the Board of Adjustment shall not grant a variance unless the petition demonstrates compliance with six (6) criteria. Marion County Staff analysis of compliance with the six (6) criteria is provided below.

- 1. Special conditions and circumstances exist which are peculiar to the land, structure or building involved and which are not applicable to other lands, structures or buildings with the same zoning classification and land use area.

Analysis: The applicants state they are requesting a setback reduction from 75' to 27' from the high water line mark on the westerly property boundary to allow a 4' addition to an existing deck and also add a proposed porch cover over the same deck for shade. The home was developed in it's current located to avoid a designated wetland area that encompasses the rest of the subject parcel to east. The development area for this subdivision is limited by ESOZ setbacks and this wetland area.

- 2. The special conditions and circumstances do not result from the actions of the applicant.

Analysis: The applicants state that the variance request will not move trees or land and is only adding on to existing deck and extending deck 4'. Staff finds the wetland area on-site would limit land capable of being developed to the current location.

- 3. Literal interpretation of the provisions of applicable regulations would deprive the applicant of rights commonly enjoyed by other properties with the same zoning classification and land use area under the terms of said regulations and would cause unnecessary and undue hardship on the applicant.

Analysis: Granting of this variance would not be irregular to the surrounding area. This would not adversely affect any property owners. As shown below several lots in this area have also received approved variances. The applicant states it would follow suit to the neighbor's additions that were granted.

- ❖ **060801V** ESOZ @ 58' for SFR addition – **approved**
- ❖ **070502V** ESOZ @ 60' for porch addition **approved;**
- ❖ **110602V** ESOZ @ 30' convert deck to room addition – **approved**
- ❖ **200701V** ESOZ @ 47' for mother-in-law suite & a pool **approved**

- 4. The variance, if granted, is the minimum variance that will allow the reasonable use of the land, building or structure.

Analysis: The applicants state that the request for the reduction in setbacks from 75' to 27' for the front (lakeside) to the high water line mark for a 4' addition to the existing deck and the proposed covered porch over the same deck is the minimum needed to develop at the desired location on an ESOZ body of water and provide ample coverage over the deck to allow for a proper amount of shade.

5. Granting the variance requested will not confer on the applicant any special privilege that is denied by these regulations to other lands, buildings or structures in the same zoning classification and land use area.

Analysis: Applicants state that the variance will not confer on the applicants any special privilege than other owners in the area since so many variances as shown above have been approved for similar requests.

6. The granting of the variance will not be injurious to the neighborhood or otherwise detrimental to the public welfare.

Analysis: Applicants state this would not adversely affect any of the surrounding parcels since there are so many other parcels that were granted similar variances. Granting of this variance should not be injurious to the neighborhood or otherwise detrimental to the public welfare.

V. LIST OF ATTACHMENTS

- A. Application
- B. Public Notice Sign
- C. Survey
- D. Site Plan
- E. Aerial
- F. Deed
- G. Property Card
- H. Variances in Area



Marion County
Board of County Commissioners
Growth Services
2710 E. Silver Springs
Blvd. Ocala, FL 34470
Phone: 352-438-2675 Fax:
352-438-2676

OFFICE USE ONLY
Received By: C. Naugh
Date Received: 5-17-24
240803V

VARIANCE APPLICATION

AR#: 31565

Application #: 240803V
FOR COUNTY USE ONLY

PA#: 49167-004-00
Parcel Account Number of Subject Property

THE UNDERSIGNED REQUESTS A VARIANCE AS REFERENCED IN SECTION 2.9 OF THE MARION COUNTY LAND DEVELOPMENT FOR THE PURPOSE OF: Reduce ESOZ front (Lakeside) setback from

Add Cover for Existing front porch (LAKE side) from 75' to 27'
FOR ESOZ. (House built in 1998 prior to ESOZ, porch existing. Add 4'
Add Garage to dwelling toward roadside. Extend existing GARAGE
25'. Lot is 1,157 sq. ft. in depth. for a proposed covered porch addition to an
existing deck.

Section of Code requesting variance from: 5.2.4.A waterfront setbacks ESOZ

Legal Description (Please attach a copy of deed). Total Acreage of subject property: 3.13 +/- acres

Directions to subject property:

R-3 + R-1

Travel South on HWY 25 from Ocklawaha. Turn Right into
Lake weir Landing. Gate Code 2323. Straight, bare to the
right - 6th house on the left

Please Note: **Property owner must sign this application:** Otherwise he/she must attach to this application written authorization naming an agent to act in his/her behalf.

Roger D. Gantner, TR
(Print/Signature) Property Owner

Nedene E Gantner, TR
(Print) Applicant or Agent

13584 S. HWY 25
Address

13584 S. Hwy 25
Address

East Lake Weir FL 32133
City, State, Zip Code

East Lake Weir FL 32133
City, State, Zip Code

352-267-3014
Contact Info: Phone, cell, e-mail address

352-267-3014 Deltboye@gmail.com
Contact Info: Phone, cell, e-mail address

THE FILING FEE IS \$ 550 NON-REFUNDABLE. WE RECOMMEND THAT THE OWNER, APPLICANT OR AGENT BE PRESENT AT THE HEARING. IF NO REPRESENTATIVE IS PRESENT AND THE BOARD REQUIRES ADDITIONAL INFORMATION, THEY MAY DECIDE TO POSTPONE OR DENY THE REQUEST. NOTICE OF SAID HEARING WILL BE MAILED TO THE ABOVE ADDRESS. ALL INFORMATION GIVEN MUST BE CORRECT AND LEGIBLE TO BE PROCESSED. PLEASE NOTE THAT A WRITTEN PETITION (REFER TO PAGE 2 & 3) MUST BE PROVIDED WITH THIS APPLICATION, ALONG WITH A SITE PLAN IN ORDER TO BE CONSIDERED COMPLETE. FOR FURTHER INFORMATION CONTACT THE MARION COUNTY GROWTH SERVICES.

Project: 2024050046
AR: 31565

Sec. 09-17-24
"Lake Weir Landing"

WRITTEN PETITION FOR VARIANCE

WRITE YOUR ANSWERS IN THE SPACE PROVIDED AFTER EACH STATEMENT. PLEASE COMPLETE ALL REPLIES USING A SENTENCE FORM. A VARIANCE FROM THE TERMS OF THESE REGULATIONS SHALL NOT BE GRANTED BY THE BOARD OF ADJUSTMENT UNLESS A WRITTEN PETITION FOR A VARIANCE IS SUBMITTED JUSTIFYING THE FOLLOWING:

A. Special conditions and circumstances exist which are peculiar to the land, structure or building involved and which are not applicable to other lands, structures or buildings with the same zoning classification and land use area.

Applicant's justification:

1. We are asking for additional feet from our existing deck to add a covered porch for shade. Requesting a reduction from 75 feet to 27 feet to water line (high water line mark) ESOZ
2. Requesting to add Garage 25x34 to the back of the home. (roadside)
Property depth is 1,157'

B. The special conditions and circumstances do not result from the actions of the applicant.

Applicant's justification:

1. No trees or land moved. Only adding cover for shade onto deck + extend existing deck 4'
2. No trees removed or water run off to the lake. water will flow to the 3 acres opposite of Lake.

C. Literal interpretation of the provisions of applicable regulations would deprive the applicant of rights commonly enjoyed by other properties with the same zoning classification and land use are under the terms of said regulations and would work unnecessary and undue hardship on the applicant.

Applicant's justification:

Granting of this variance would not be irregular to the surrounding area. This would not adversely effect any property owners. It would follow suit to neighbors additions that were granted.

D. The Variance, if granted, is the minimum Variance that will allow the reasonable use of the land, building or structure.

Applicant's justification:

1. The reduction of 75 ft to 27 ft is the minimum needed to develop at desired location (ES02)

2. The 25x34 Garage is within our set backs & will not impact neighbors or water
 no variance needed or requested.

E. Granting the Variance requested will not confer on the applicant any special privilege that is denied by these regulations to other lands, buildings or structures in the same zoning classification and land use area.

Applicant's justification:

True

F. The granting of the Variance will not be injurious to the neighborhood or otherwise detrimental to the public welfare.

Applicant's justification:

True

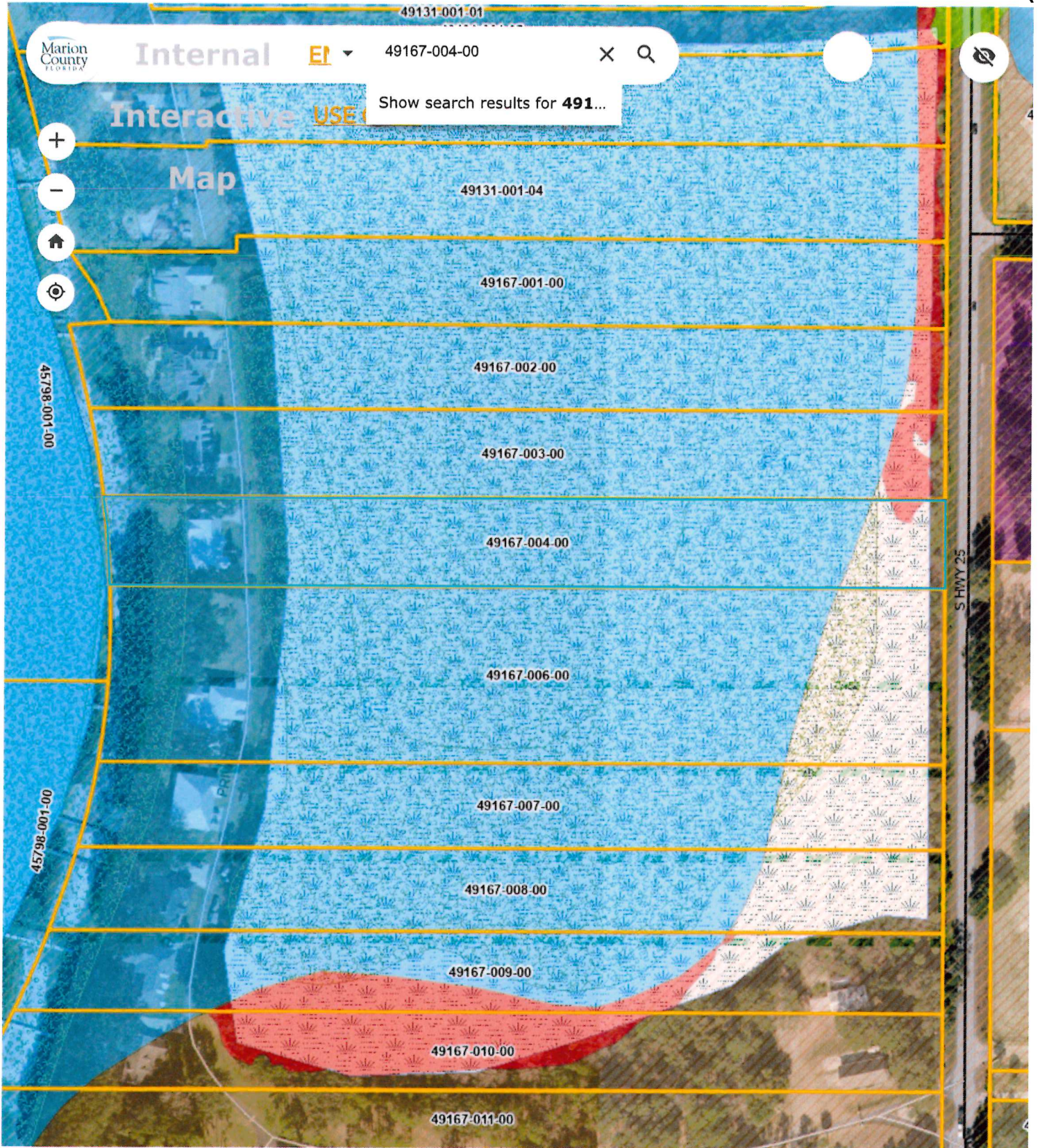







Jimmy H. Cowan, Jr., CFA
Marion County Property Appraiser - Beta Map It+

Updated every 24 hrs

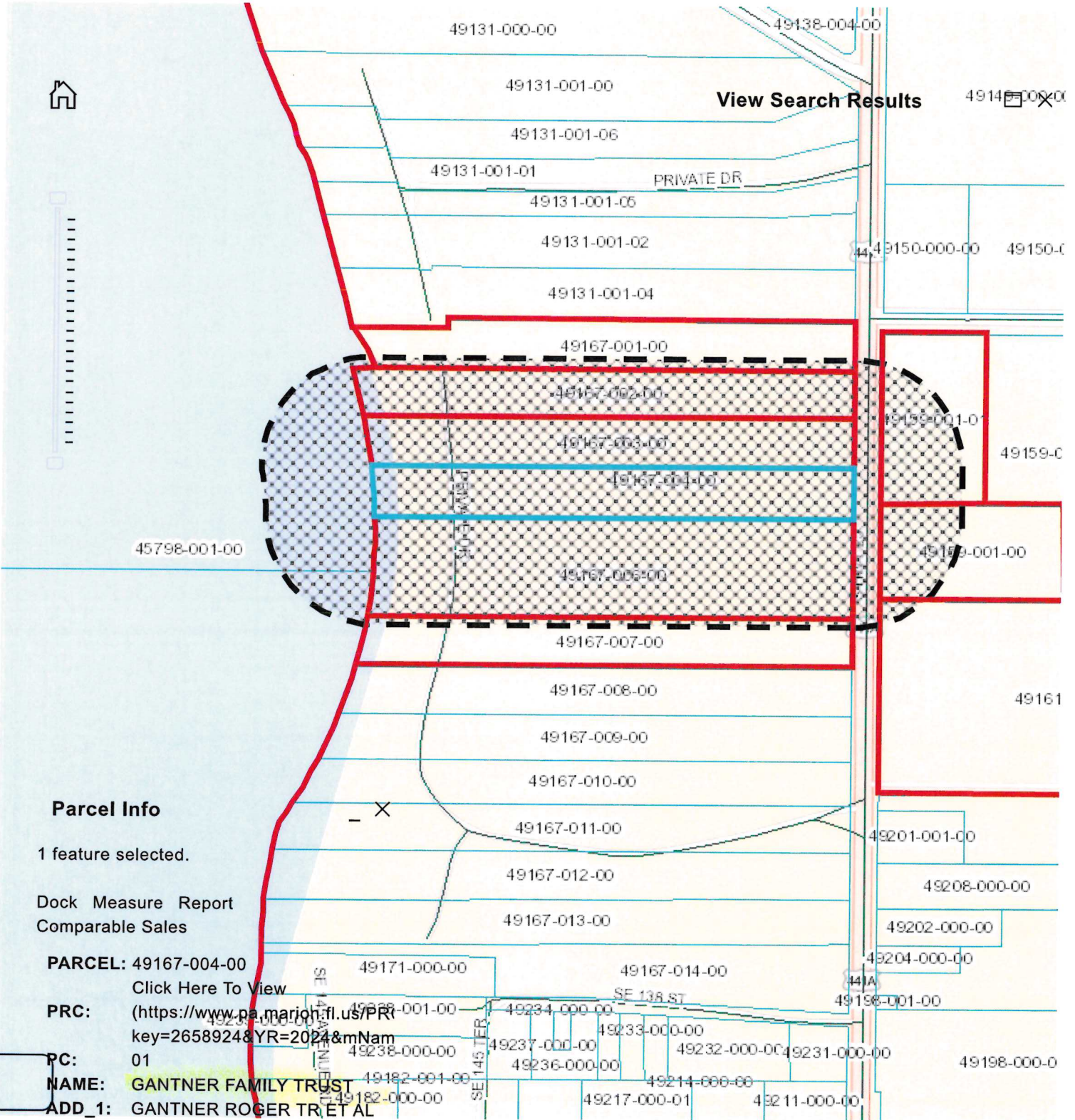

Parcel Info

1 feature selected.

Dock Measure Report
Comparable Sales

PARCEL: 49167-004-00

[Click Here To View](#)

PRC: (<https://www.pa.marion.fl.us/PRIkey=2658924&YR=2024&mNam>)

PC: 01

NAME: GANTNER FAMILY TRUST

ADD_1: GANTNER ROGER TR ET AL

ADD_2: PO BOX 128

ADD_3: EAST LAKEWEIR FL 32133-012

2024-03-07A

[Click here for Legal Disclaimer](#)

Jimmy H. Cowan, Jr., CFA
Marion County Property Appraiser



501 SE 25th Avenue, Ocala, FL 34471 Telephone: (352) 368-8300 Fax: (352) 368-8336

2024 Property Record Card
Real Estate

49167-004-00 ✓

[GOOGLE Street View](#)

Prime Key: 2658924

[Beta MAP IT+](#)

Current as of 5/21/2024

[Property Information](#)

[Less Names](#)

GANTNER FAMILY TRUST
 GANTNER ROGER TR ✓
 GANTNER NOELENE TR ✓
 PO BOX 128
 EAST LAKEWEIR FL 32133-0128

[Taxes / Assessments:](#)

Map ID: 313

[Millage:](#) 9001 - UNINCORPORATED

[M.S.T.U.](#)

PC: 01

✓ Acres: 3.13

✓ [Situs:](#) Situs: 13584 S HWY 25 EAST LAKE WEIR

[2023 Certified Value](#)

Land Just Value	\$314,406		
Buildings	\$352,083		
Miscellaneous	\$5,303		
Total Just Value	\$671,792		
Total Assessed Value	\$643,720	Impact	(\$28,072)
Exemptions	(\$50,000)	Ex Codes: 01 38	
Total Taxable	\$593,720		
School Taxable	\$618,720		

[History of Assessed Values](#)

Year	Land Just	Building	Misc Value	Mkt/Just	Assessed Val	Exemptions	Taxable Val
2023	\$314,406	\$352,083	\$5,303	\$671,792	\$643,720	\$50,000	\$593,720
2022	\$308,794	\$317,959	\$5,394	\$632,147	\$624,971	\$50,000	\$574,971
2021	\$252,674	\$226,190	\$4,999	\$483,863	\$468,950	\$0	\$468,950

[Property Transfer History](#)

Book/Page	Date	Instrument	Code	Q/U	V/I	Price
7534/0539	08/2021	07 WARRANTY	9 UNVERIFIED	Q	I	\$610,000
2527/0742	07/1998	07 WARRANTY	2 V-SALES VERIFICATION	U	I	\$245,000
2346/0642	03/1997	07 WARRANTY	2 V-SALES VERIFICATION	U	V	\$77,000
2346/0640	02/1997	08 CORRECTIVE	0	U	V	\$100
1736/0359	04/1991	07 WARRANTY	0	U	V	\$100

[Property Description](#)

SEC 09 TWP 17 RGE 24 ✓
 PLAT BOOK UNR

LAKE WEIR LANDING ✓

LOT 4 BEING MORE FULLY DESC AS FOLLOWS:

COM AT THE SE COR TH S 89-50-00 W ALONG THE S BDY LINE
1359.50 FT TH N 00-13-35 W 984.20 FT SAID POINT BEING
ON THE WLY ROW LINE OF CR C-25 TH N 00-14-25 W ALONG
SAID ROW LINE 1194.35 FT TO THE POB TH CONT ALONG SAID
ROW LINE N 00-14-25 W 121.03 FT TH DEPARTING FROM SAID
ROW LINE S 89-25-56 W 1124.88 FT TO THE ORDINARY HIGH
WATER LINE OF LAKE WEIR TH MEANDERING SAID ORDINARY HIGH
WATER LINE S 00-38-37 E 14.31 FT TH S 07-23-48 E 100.19 FT
TH S 01-36-56 W 7.25 FT TH DEPARTING FROM SAID ORDINARY
HIGH WATER LINE N 89-25-56 E 1112.53 FT TO THE POB

Parent Parcel: 49167-000-00

[Land Data - Warning: Verify Zoning](#)

Use	CUse	Front	Depth	Zoning	Units	Type	Rate	Loc	Shp	Phy	Class	Value	Just Value
0130		122.0	157.0	R3	122.00	FF							
9610		.0	.0	R1	2.69	AC							
9480		.0	.0	R1	1.00	UT							

Neighborhood 8090 - LAKE WEIR - NOT S & SW
Mkt: 10 70

[Traverse](#)

Building 1 of 1

RES01=D36R14U12R16D8R12U4R22U46L23D18L1U
2L7D2L3U4L17D4L13.
FSP02=U14R41D14L1U2L7D2L3U4L17D4L13.D36R
14U6
FOP03=U6R16D6L16.R16D2R12U4U42L15
DCK04=U12L27D12R27.R34D17R15
FCP05=L12D25R12U25.
FST06=R7D25L7U25.L8
PTO07=R20U15L20D15.

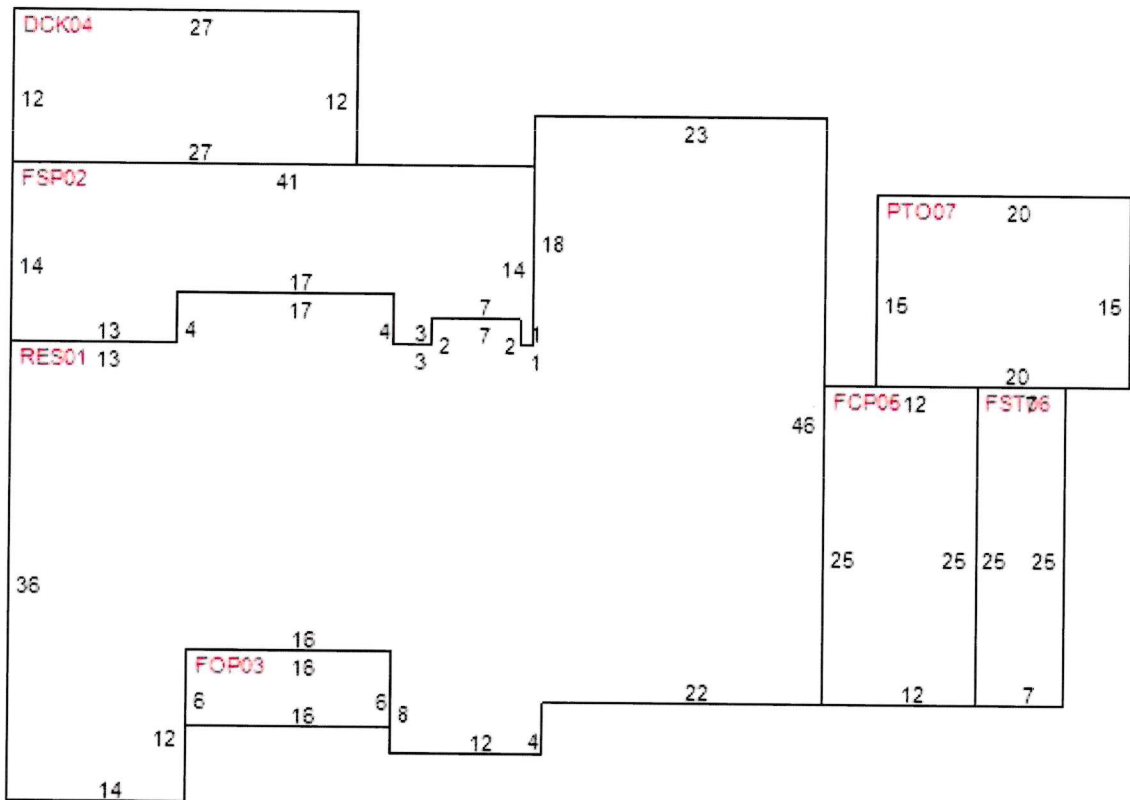

Building Characteristics

Improvement 1F - SFR- 01 FAMILY RESID
Effective Age 3 - 10-14 YRS
Condition 4
Quality Grade 700 - GOOD
Inspected on 9/8/2014 by 187

Year Built 1998
Physical Deterioration 0%
Obsolescence: Functional 0%
Obsolescence: Locational 0%
Architecture 0 - STANDARD SFR
Base Perimeter 264

Type	ID	Exterior Walls	Stories	Year Built	Finished	Attic	Bsmt	Area	Bsmt	Finish	Ground Floor Area	Total Flr Area
RES	0132	- CONC BLK-STUCO	1.00	1998	N	0 %	0 %				2,384	2,384
FSP	0201	- NO EXTERIOR	1.00	1998	N	0 %	0 %				492	492
FOP	0301	- NO EXTERIOR	1.00	1998	N	0 %	0 %				96	96
DCK	0401	- NO EXTERIOR	1.00	1998	N	0 %	0 %				324	324
FCP	0501	- NO EXTERIOR	1.00	2008	N	0 %	0 %				300	300
FST	0632	- CONC BLK-STUCO	1.00	2008	N	0 %	0 %				175	175
PTO	0701	- NO EXTERIOR	1.00	2008	N	0 %	0 %				300	300

Section: 1

Roof Style: 10 GABLE **Floor Finish:** 24 CARPET **Bedrooms:** 3 **Blt-In Kitchen:** Y
Roof Cover: 08 FBRGLASS SHNGL **Wall Finish:** 16 DRYWALL-PAINT **4 Fixture Baths:** 1 **Dishwasher:** Y
Heat Meth 1: 20 HEAT PUMP **Heat Fuel 1:** 10 ELECTRIC **3 Fixture Baths:** 1 **Garbage Disposal:** N

Heat Meth 2: 00	Heat Fuel 2: 00	2 Fixture Baths: 0	Garbage Compactor: N
Foundation: 7 BLK PERIMETER	Fireplaces: 0	Extra Fixtures: 4	Intercom: N
A/C: Y			Vacuum: N

Miscellaneous Improvements

Type	Nbr Units	Type	Life	Year In	Grade	Length	Width
159 PAV CONCRETE	578.00	SF	20	1998	3	0.0	0.0
190 SEPTIC 1-5 BTH	1.00	UT	99	1998	2	0.0	0.0
030 DOCK WOOD	772.00	SF	10	1998	2	0.0	0.0
159 PAV CONCRETE	532.00	SF	20	2008	3	0.0	0.0
BTH BOAT HOUSE	288.00	SF	40	2006	2	12.0	24.0

Appraiser Notes

VRBO RENTAL LISTING#321767

Planning and Building

** Permit Search **

Permit Number	Date Issued	Date Completed	Description
2021082001	8/18/2021	9/15/2021	REMOVING SHINGLES AND REPLACING WITH METAL ON AN SFR. FL#72
M120736	12/1/2007	10/1/2008	ADD STORAGE ,ENC GARAGE
MC13018	3/1/1997	2/1/1998	SFR

THIS INSTRUMENT PREPARED BY AND RETURN TO:

Robin White
Equitable Title of Ocala, LLC
109 SE 1st Avenue
Ocala, FL 34471
OC210769

✓ Property Appraisers Parcel Identification (Folio) Number:
49167-004-00

WARRANTY DEED

_____ SPACE ABOVE THIS LINE FOR RECORDING DATA _____

✓ THIS WARRANTY DEED, made this 4th day of August, 2021 by Barbara G. Musleh herein called the grantor(s), to Roger Gantner and Noelene Gantner, as Trustees of the Gantner Family Trust whose post office address is 41420 Sleepy Lane, W Jesudall, FL 32159, hereinafter called the Grantee(s):

(Wherever used herein the terms "grantor" and "grantee" include all the parties to this instrument and the heirs, legal representatives and assigns of individuals, and the successors and assigns of corporations)

W I T N E S S E T H: That the grantor(s), for and in consideration of the sum of SIX HUNDRED TEN THOUSAND AND 00/100 DOLLARS (U.S. \$610,000.00) and other valuable considerations, receipt whereof is hereby acknowledged, hereby grants, bargains, sells, aliens, remises, releases, conveys and confirms unto the grantee all that certain land situate in Marion County, State of Florida, viz.:

LOT 4 LAKE WEIR LANDING,

A PARCEL OF LAND LYING WITHIN SECTION 9, TOWNSHIP 17 SOUTH, RANGE 24 EAST, MARION COUNTY, FLORIDA, MORE PARTICULARLY DESCRIBED AS FOLLOWS:

COMMENCE AT THE SOUTHEAST CORNER OF SAID SECTION 9; THENCE SOUTH 89° 50' 00" WEST ALONG THE SOUTH BOUNDARY LINE OF SAID SECTION 9 A DISTANCE OF 1,359.50 FEET; THENCE NORTH 00° 13' 35" WEST A DISTANCE OF 984.20 FEET, SAID POINT BEING ON THE WESTERLY RIGHT OF WAY LINE OF COUNTY ROAD NO. C-25; THENCE NORTH 00° 14' 25" WEST ALONG SAID RIGHT OF WAY LINE A DISTANCE OF 1,194.35 FEET TO THE POINT OF BEGINNING; THENCE CONTINUE ALONG SAID RIGHT OF WAY LINE NORTH 00° 14' 25" WEST A DISTANCE OF 121.03 FEET; THENCE DEPARTING FROM SAID RIGHT OF WAY LINE SOUTH 89° 25' 56" WEST A DISTANCE OF 1,124.88 FEET TO THE ORDINARY HIGH WATER LINE OF LAKE WEIR; THENCE MEANDERING SAID ORDINARY HIGH WATER LINE SOUTH 00° 38' 37" EAST A DISTANCE OF 14.31 FEET; THENCE SOUTH 07° 23' 48" EAST A DISTANCE OF 100.19 FEET; THENCE SOUTH 01° 36' 56" WEST A DISTANCE OF 7.25 FEET; THENCE DEPARTING FROM SAID ORDINARY HIGH WATER LINE NORTH 89° 25' 56" EAST A DISTANCE OF 1,112.53 FEET TO THE POINT OF BEGINNING.

THE ABOVE DESCRIBED PROPERTY IS NOT THE HOMESTEAD NOR IS IT CONTIGUOUS TO THE HOMESTEAD OF GRANTOR. GRANTOR RESIDES AT: 2435 SE Woodlea Circle Ocala, FL 34471

TOGETHER, with all the tenements, hereditaments and appurtenances thereto belonging or in anywise appertaining.

TO HAVE AND TO HOLD, the same in fee simple forever.

AND, the grantor(s) hereby covenant(s) with said grantee(s) that the grantor(s) is/are lawfully seized of said land in fee simple; that the grantor(s) has/have good right and lawful authority to sell and convey said land, and hereby warrant(s) the title to said land and will defend the same against the lawful claims of all persons whomsoever; and that said land is free of all encumbrances, except taxes accruing subsequent to December 31, 2020.

IN WITNESS WHEREOF, the said grantor(s) has/have signed and sealed these presents the day and year first above written.

Signed, sealed and delivered in the presence of:

[Signature]
Witness #1 Signature

[Signature]
Barbara G. Musleh

Eric Patrono
Witness #1 Printed Name

Whose mailing address is:
2435 SE Woodhewer Cir
Orlando, FL 32847

[Signature]
Witness #2 Signature

ROBIN R WHITE
Witness #2 Printed Name

State of Florida
County of Marion

The foregoing instrument was acknowledged before me by means of physical presence or online notarization, this 4th day of August, 2021, by **Barbara G. Musleh**, she is personally known to me or has produced D.C. as identification.

SEAL

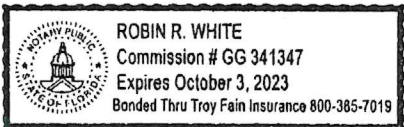

[Signature]
Notary Public

ROBIN R WHITE
Printed Notary Name

My Commission Expires:



ZONING
Notice of Public Hearing
Marion County
Application is being made to:

Change zoning from:
to:

Special Use Permit

Variance to Section 22.02.010

On this property which is owned by:

By: _____
Date: _____

It is intended to remove this notice and the above mentioned
from hearing and make final.

D & A DESIGN
Zoning Director: _____

Attachment D - Survey

BOUNDARY SURVEY

PAGE 1 OF 1

LEGAL DESCRIPTION:

LOT 4, LAKE WEIR LANDING,
A PARCEL OF LAND LYING WITHIN SECTION 9, TOWNSHIP 17 SOUTH, RANGE 24 EAST, MARION COUNTY, FLORIDA, MORE PARTICULARLY DESCRIBED AS FOLLOWS:
COMMENCE AT THE SOUTHEAST CORNER OF SAID SECTION 9; THENCE SOUTH 89°50'00" WEST, ALONG THE SOUTH BOUNDARY LINE OF SAID SECTION 9, A DISTANCE OF 1359.50 FEET, THENCE NORTH 00°13'35" WEST, A DISTANCE OF 984.20 FEET, SAID POINT BEING ON THE WESTERLY RIGHT OF WAY LINE OF COUNTY ROAD NO. C-25; THENCE NORTH 00°14'25" WEST, ALONG SAID RIGHT OF WAY LINE A DISTANCE OF 1194.35 FEET TO THE POINT OF BEGINNING;

THENCE CONTINUE ALONG SAID RIGHT OF WAY LINE NORTH 00°14'25" WEST, A DISTANCE OF 121.03 FEET; THENCE DEPARTING FROM SAID RIGHT OF WAY LINE SOUTH 89°25'56" WEST, A DISTANCE OF 1124.88 FEET TO THE ORDINARY HIGH WATER LINE OF LAKE WEIR; THENCE MEANDERING SAID ORDINARY HIGH WATER LINE SOUTH 00°38'37" EAST, A DISTANCE OF 14.31 FEET; THENCE SOUTH 07°23'48" EAST, A DISTANCE OF 100.19 FEET, THENCE SOUTH 01°36'58" WEST, A DISTANCE OF 7.25 FEET, THENCE DEPARTING FROM SAID ORDINARY HIGH WATER LINE, NORTH 89°25'56" EAST A DISTANCE OF 1112.53 FEET TO THE POINT OF BEGINNING.

PROPERTY ADDRESS:

FLAMINGO REAL ESTATE AND MANAGEMENT;

PROPERTY ADDRESS:
13584 EAST HIGHWAY NO. 25
LAKE WEIR, FLORIDA 32133

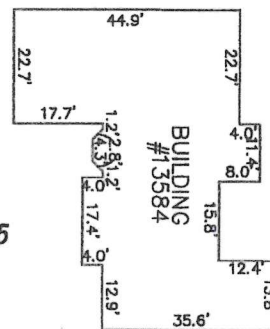

BUILDING DETAILS:
NTS

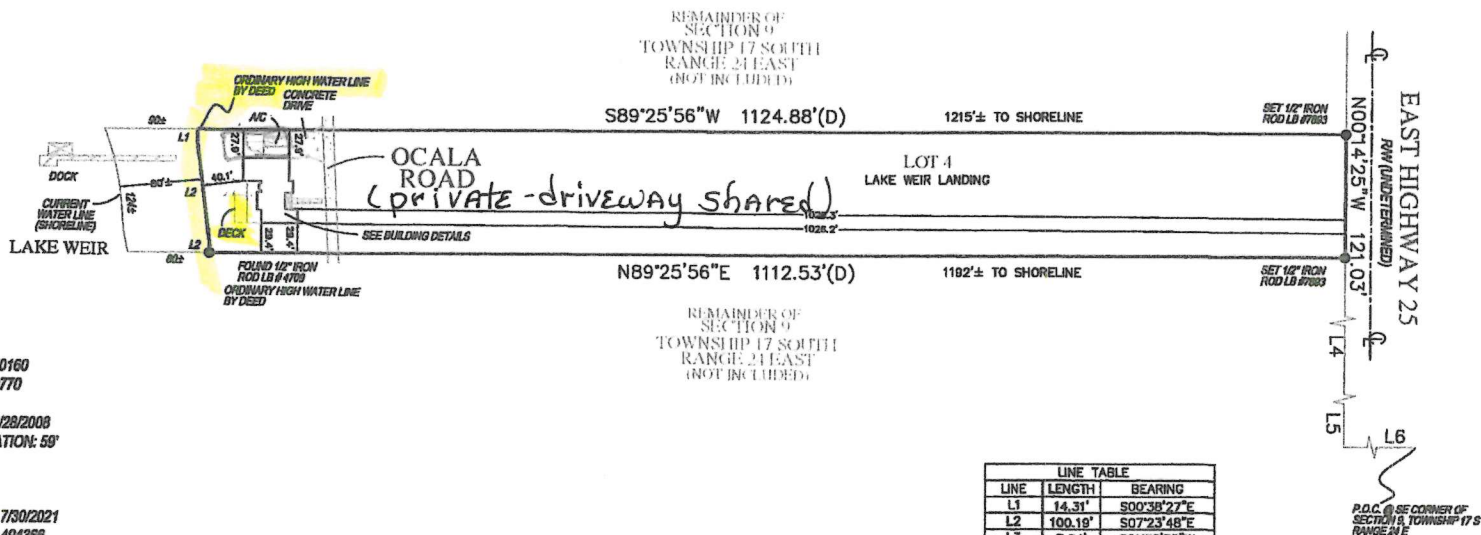

LINE	LENGTH	BEARING
L1	14.31'	S00°38'27\"E
L2	100.19'	S07°23'48\"E
L3	7.24'	S01°36'58\"W
L4	1194.35'	N00°14'25\"W
L5	984.20'	N00°13'35\"W
L6	1359.50'	S89°50'00\"W

FLOOD ZONE: AE
COMMUNITY NO. 120160
PANEL NO. 12083C0770
SUFFIX: D
FIRM/REV. DATE: 09/29/2008
BASE FLOOD ELEVATION: 59'

FIELDWORK DATE: 7/30/2021
SURVEY NUMBER: 494388
PARCEL NO. 49167-004-00.

ABBREVIATION DESCRIPTION:

- 200' = 200' CENTERLINE
- C = CENTERLINE
- R = CONTROL POINT/ANGLE
- LS = LOT SURVEY
- L = LOT
- LD = LAKEDOCK DISTRICT
- N.W.A.D. = NORTH WEST ANGLE DISTRICT
- N.E.A.D. = NORTH EAST ANGLE DISTRICT
- OC = Ocala Road
- P.C. = POINT OF CURVATURE
- P.O.C. = POINT OF CURVATURE
- P.S. = POINT OF SIGHT
- P.P.C. = POINT OF REVERSE CURVE
- P.F.M. = POINT OF FUTURE MOUNTAIN
- P.T. = POINT OF TANGENCY
- R = RIGHT OF WAY
- W = WATER
- W.W. = RIGHT OF WAY

SYMBOL DESCRIPTION:

- = CATCH BASIN
- = CENTERLINE ROAD
- = COVERED AREA
- ⊗ = EXISTED ELEVATION
- ⊕ = HIGHWAY
- ⊙ = UNKNOWN
- = METAL FENCE
- = WOOD FENCE
- = SEC. FENCE
- = PROPERTY CORNER
- = UTILITY BOX
- = UTILITY POLE
- ⊕ = WATER METER
- ⊙ = WELL

SURVEYORS CERTIFICATE
I HEREBY CERTIFY THAT THIS BOUNDARY SURVEY IS A TRUE AND CORRECT REPRESENTATION OF A SURVEY PREPARED UNDER MY DIRECTION NOT VALID WITHOUT A RAISED EMBOSSED SEAL AND SIGNATURE.

Digitally signed by
Kenneth Osborne
Date: 2021.09.02 13:03:25 -0400
Kenneth J. Osborne
PROFESSIONAL SURVEYOR AND MAPPER #5415

SURVEY NOTES

- WOOD DOCK AREA FALLS IN LAKE LEIR AREA

SCALE: 1/8\"/>

THIS SURVEY WAS CONDUCTED IN ACCORDANCE WITH THE FLORIDA SURVEYING AND MAPPING ACT, CHAPTER 461, F.S. THE SURVEYOR'S SEAL AND SIGNATURE ARE REQUIRED ON ALL SURVEY INSTRUMENTS. THIS SURVEY WAS CONDUCTED IN ACCORDANCE WITH THE FLORIDA SURVEYING AND MAPPING ACT, CHAPTER 461, F.S. THE SURVEYOR'S SEAL AND SIGNATURE ARE REQUIRED ON ALL SURVEY INSTRUMENTS. THIS SURVEY WAS CONDUCTED IN ACCORDANCE WITH THE FLORIDA SURVEYING AND MAPPING ACT, CHAPTER 461, F.S. THE SURVEYOR'S SEAL AND SIGNATURE ARE REQUIRED ON ALL SURVEY INSTRUMENTS.

TARGET SURVEYING, LLC

WATER Line (high)

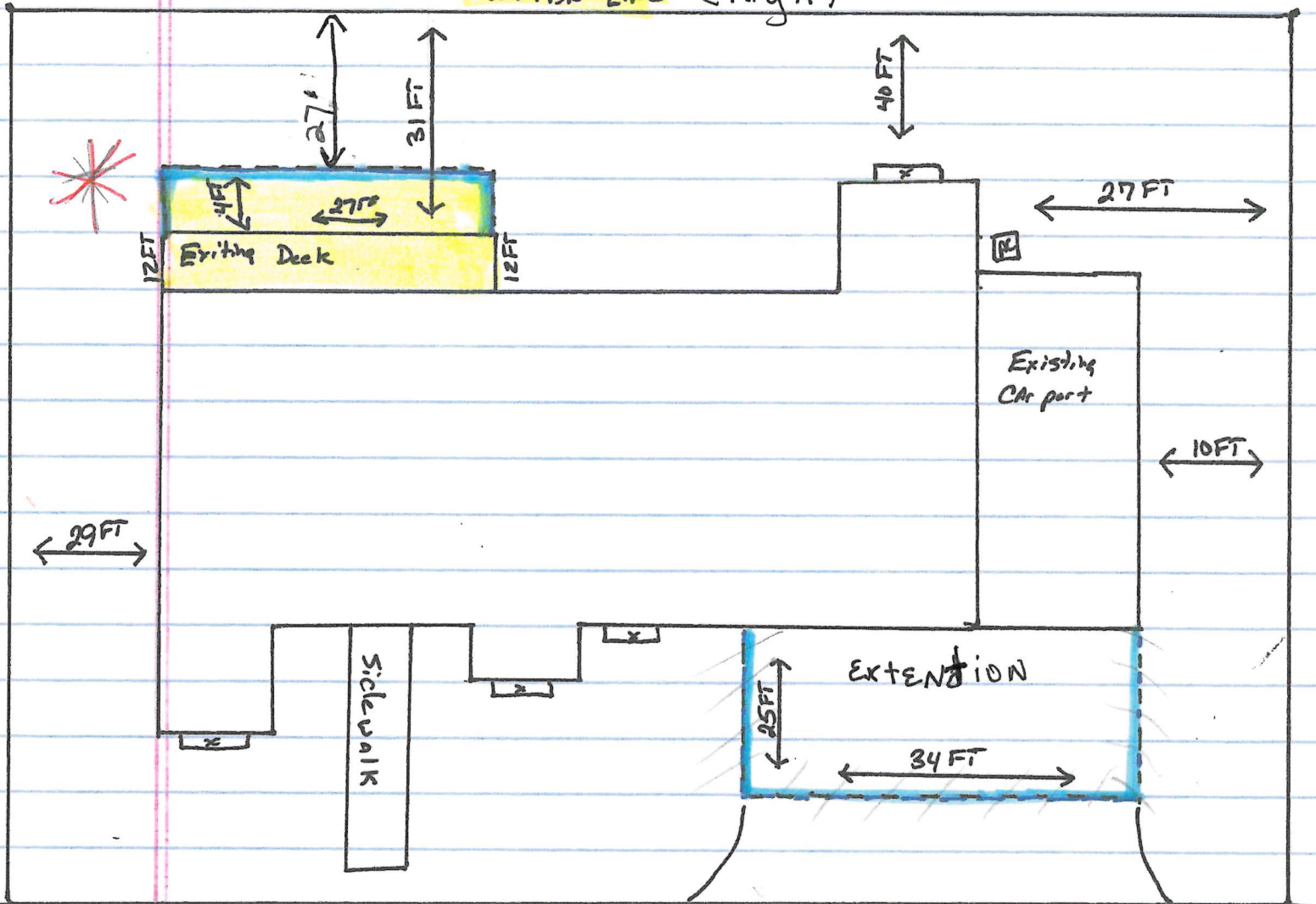

Asphalt Private Drive - way

property line 1,157 ft depth

Front Property

13584 East Highway 25
East Lake Weir, FL 32133

Attachment F: Aerial

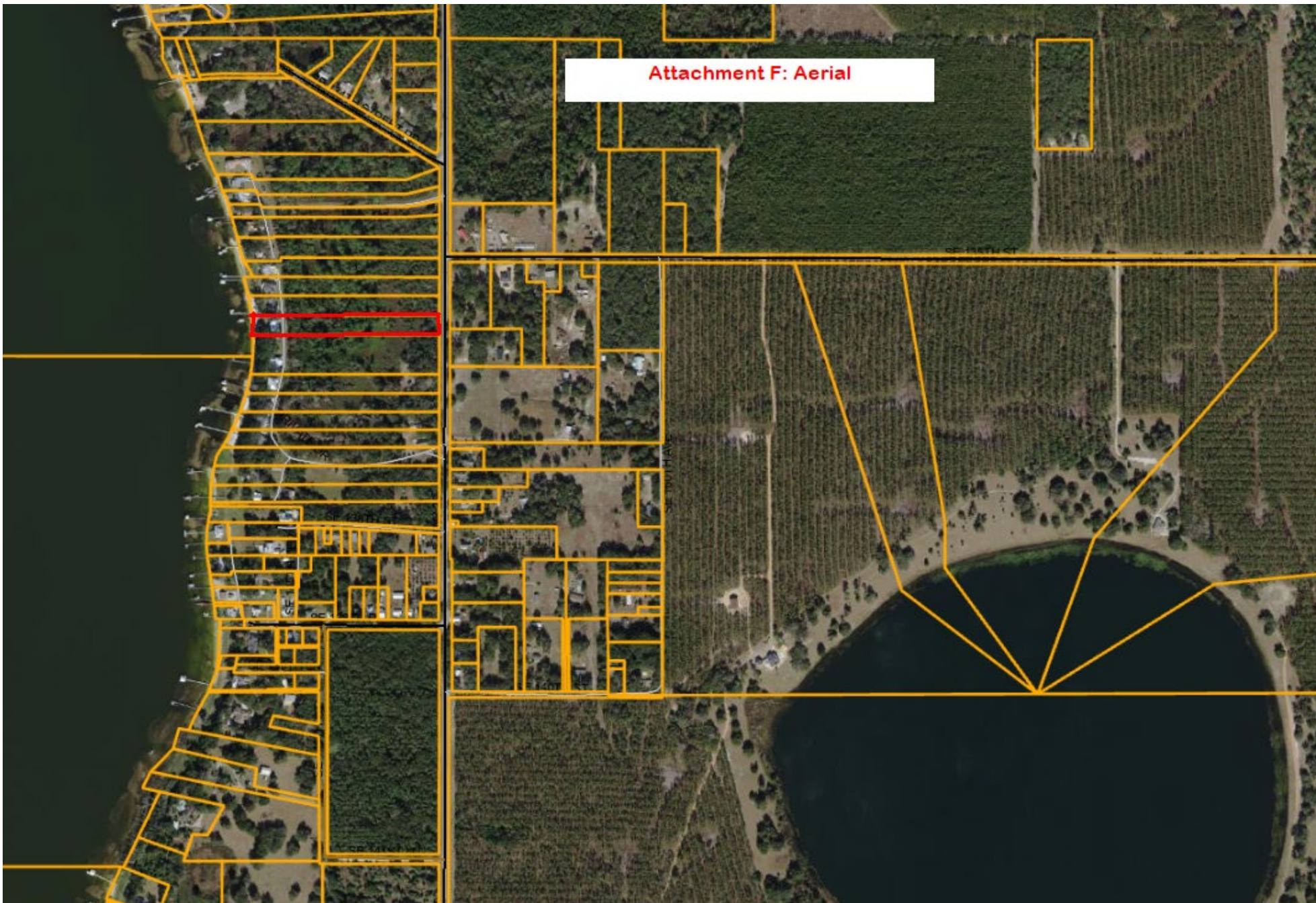

Attachment G: Deed

THIS INSTRUMENT PREPARED BY AND RETURN TO:
Robin White
Equitable Title of Ocala, LLC
109 SE 1st Avenue
Ocala, FL 34471
OC210769

✓ Property Appraisers Parcel Identification (Folio) Number:
49167-004-00

WARRANTY DEED

_____SPACE ABOVE THIS LINE FOR RECORDING DATA_____

✓ THIS WARRANTY DEED, made this 4th day of August, 2021 by Barbara G. Musleh herein called the grantor(s), to Roger Gantner and Noelene Gantner, as Trustees of the Gantner Family Trust whose post office address is 41420 Sleepy Lane, W Jesudall, FL 32159, hereinafter called the Grantee(s):
(Wherever used herein the terms "grantor" and "grantee" include all the parties to this instrument and the heirs, legal representatives and assigns of individuals, and the successors and assigns of corporations)

W I T N E S S E T H: That the grantor(s), for and in consideration of the sum of SIX HUNDRED TEN THOUSAND AND 00/100 DOLLARS (U.S. \$610,000.00) and other valuable considerations, receipt whereof is hereby acknowledged, hereby grants, bargains, sells, aliens, remises, releases, conveys and confirms unto the grantee all that certain land situate in Marion County, State of Florida, viz.:

LOT 4 LAKE WEIR LANDING,

A PARCEL OF LAND LYING WITHIN SECTION 9, TOWNSHIP 17 SOUTH, RANGE 24 EAST, MARION COUNTY, FLORIDA, MORE PARTICULARLY DESCRIBED AS FOLLOWS:

COMMENCE AT THE SOUTHEAST CORNER OF SAID SECTION 9; THENCE SOUTH 89° 50' 00" WEST ALONG THE SOUTH BOUNDARY LINE OF SAID SECTION 9 A DISTANCE OF 1,359.50 FEET; THENCE NORTH 00° 13' 35" WEST A DISTANCE OF 984.20 FEET, SAID POINT BEING ON THE WESTERLY RIGHT OF WAY LINE OF COUNTY ROAD NO. C-25; THENCE NORTH 00° 14' 25" WEST ALONG SAID RIGHT OF WAY LINE A DISTANCE OF 1,194.35 FEET TO THE POINT OF BEGINNING; THENCE CONTINUE ALONG SAID RIGHT OF WAY LINE NORTH 00° 14' 25" WEST A DISTANCE OF 121.03 FEET; THENCE DEPARTING FROM SAID RIGHT OF WAY LINE SOUTH 89° 25' 56" WEST A DISTANCE OF 1,124.88 FEET TO THE ORDINARY HIGH WATER LINE OF LAKE WEIR; THENCE MEANDERING SAID ORDINARY HIGH WATER LINE SOUTH 00° 38' 37" EAST A DISTANCE OF 14.31 FEET; THENCE SOUTH 07° 23' 48" EAST A DISTANCE OF 100.19 FEET; THENCE SOUTH 01° 36' 56" WEST A DISTANCE OF 7.25 FEET; THENCE DEPARTING FROM SAID ORDINARY HIGH WATER LINE NORTH 89° 25' 56" EAST A DISTANCE OF 1,112.53 FEET TO THE POINT OF BEGINNING.

THE ABOVE DESCRIBED PROPERTY IS NOT THE HOMESTEAD NOR IS IT CONTIGUOUS TO THE HOMESTEAD OF GRANTOR. GRANTOR RESIDES AT: 2435 SE Woodlea Circle Ocala, FL 34471

TOGETHER, with all the tenements, hereditaments and appurtenances thereto belonging or in anywise appertaining.

TO HAVE AND TO HOLD, the same in fee simple forever.

AND, the grantor(s) hereby covenant(s) with said grantee(s) that the grantor(s) is/are lawfully seized of said land in fee simple; that the grantor(s) has/have good right and lawful authority to sell and convey said land, and hereby warrant(s) the title to said land and will defend the same against the lawful claims of all persons whomsoever; and that said land is free of all encumbrances, except taxes accruing subsequent to December 31, 2020.

IN WITNESS WHEREOF, the said grantor(s) has/have signed and sealed these presents the day and year first above written.

Signed, sealed and delivered in the presence of:

[Signature]
Witness #1 Signature

Eric Patrono
Witness #1 Printed Name

[Signature]
Witness #2 Signature

ROBIN R WHITE
Witness #2 Printed Name

[Signature]
Barbara G. Musleh

Whose mailing address is:

2435 SE Woodhewer Cir
Orlando, FL 32847

State of Florida
County of Marion

The foregoing instrument was acknowledged before me by means of physical presence or online notarization, this 4th day of August, 2021, by **Barbara G. Musleh**, she is personally known to me or has produced D.C. as identification.

SEAL

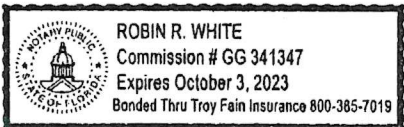

[Signature]
Notary Public

ROBIN R WHITE
Printed Notary Name

My Commission Expires:

Jimmy H. Cowan, Jr., CFA
Marion County Property Appraiser

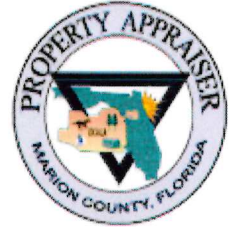

501 SE 25th Avenue, Ocala, FL 34471 Telephone: (352) 368-8300 Fax: (352) 368-8336

2024 Property Record Card
Real Estate

49167-004-00 ✓

[GOOGLE Street View](#)

Prime Key: 2658924

[Beta MAP IT+](#)

Current as of 5/21/2024

[Property Information](#)

[Less Names](#)

GANTNER FAMILY TRUST
 GANTNER ROGER TR ✓
 GANTNER NOELENE TR ✓
 PO BOX 128
 EAST LAKEWEIR FL 32133-0128

[Taxes / Assessments:](#)

Map ID: 313

[Millage:](#) 9001 - UNINCORPORATED

[M.S.T.U.](#)

PC: 01

✓ Acres: 3.13

✓ Situs: Situs: 13584 S HWY 25 EAST LAKE WEIR

[2023 Certified Value](#)

Land Just Value	\$314,406		
Buildings	\$352,083		
Miscellaneous	\$5,303		
Total Just Value	\$671,792		
Total Assessed Value	\$643,720	Impact	(\$28,072)
Exemptions	(\$50,000)	Ex Codes: 01 38	
Total Taxable	\$593,720		
School Taxable	\$618,720		

[History of Assessed Values](#)

Year	Land Just	Building	Misc Value	Mkt/Just	Assessed Val	Exemptions	Taxable Val
2023	\$314,406	\$352,083	\$5,303	\$671,792	\$643,720	\$50,000	\$593,720
2022	\$308,794	\$317,959	\$5,394	\$632,147	\$624,971	\$50,000	\$574,971
2021	\$252,674	\$226,190	\$4,999	\$483,863	\$468,950	\$0	\$468,950

[Property Transfer History](#)

Book/Page	Date	Instrument	Code	Q/U	V/I	Price
7534/0539	08/2021	07 WARRANTY	9 UNVERIFIED	Q	I	\$610,000
2527/0742	07/1998	07 WARRANTY	2 V-SALES VERIFICATION	U	I	\$245,000
2346/0642	03/1997	07 WARRANTY	2 V-SALES VERIFICATION	U	V	\$77,000
2346/0640	02/1997	08 CORRECTIVE	0	U	V	\$100
1736/0359	04/1991	07 WARRANTY	0	U	V	\$100

[Property Description](#)

SEC 09 TWP 17 RGE 24 ✓
 PLAT BOOK UNR

LAKE WEIR LANDING ✓

LOT 4 BEING MORE FULLY DESC AS FOLLOWS:
 COM AT THE SE COR TH S 89-50-00 W ALONG THE S BDY LINE
 1359.50 FT TH N 00-13-35 W 984.20 FT SAID POINT BEING
 ON THE WLY ROW LINE OF CR C-25 TH N 00-14-25 W ALONG
 SAID ROW LINE 1194.35 FT TO THE POB TH CONT ALONG SAID
 ROW LINE N 00-14-25 W 121.03 FT TH DEPARTING FROM SAID
 ROW LINE S 89-25-56 W 1124.88 FT TO THE ORDINARY HIGH
 WATER LINE OF LAKE WEIR TH MEANDERING SAID ORDINARY HIGH
 WATER LINE S 00-38-37 E 14.31 FT TH S 07-23-48 E 100.19 FT
 TH S 01-36-56 W 7.25 FT TH DEPARTING FROM SAID ORDINARY
 HIGH WATER LINE N 89-25-56 E 1112.53 FT TO THE POB

Parent Parcel: 49167-000-00

[Land Data - Warning: Verify Zoning](#)

Use	CUse	Front	Depth	Zoning	Units	Type	Rate	Loc	Shp	Phy	Class	Value	Just Value
0130		122.0	157.0	R3	122.00	FF							
9610		.0	.0	R1	2.69	AC							
9480		.0	.0	R1	1.00	UT							

Neighborhood 8090 - LAKE WEIR - NOT S & SW
 Mkt: 10 70

[Traverse](#)

Building 1 of 1

RES01=D36R14U12R16D8R12U4R22U46L23D18L1U
 2L7D2L3U4L17D4L13.
 FSP02=U14R41D14L1U2L7D2L3U4L17D4L13.D36R
 14U6
 FOP03=U6R16D6L16.R16D2R12U4U42L15
 DCK04=U12L27D12R27.R34D17R15
 FCP05=L12D25R12U25.
 FST06=R7D25L7U25.L8
 PTO07=R20U15L20D15.

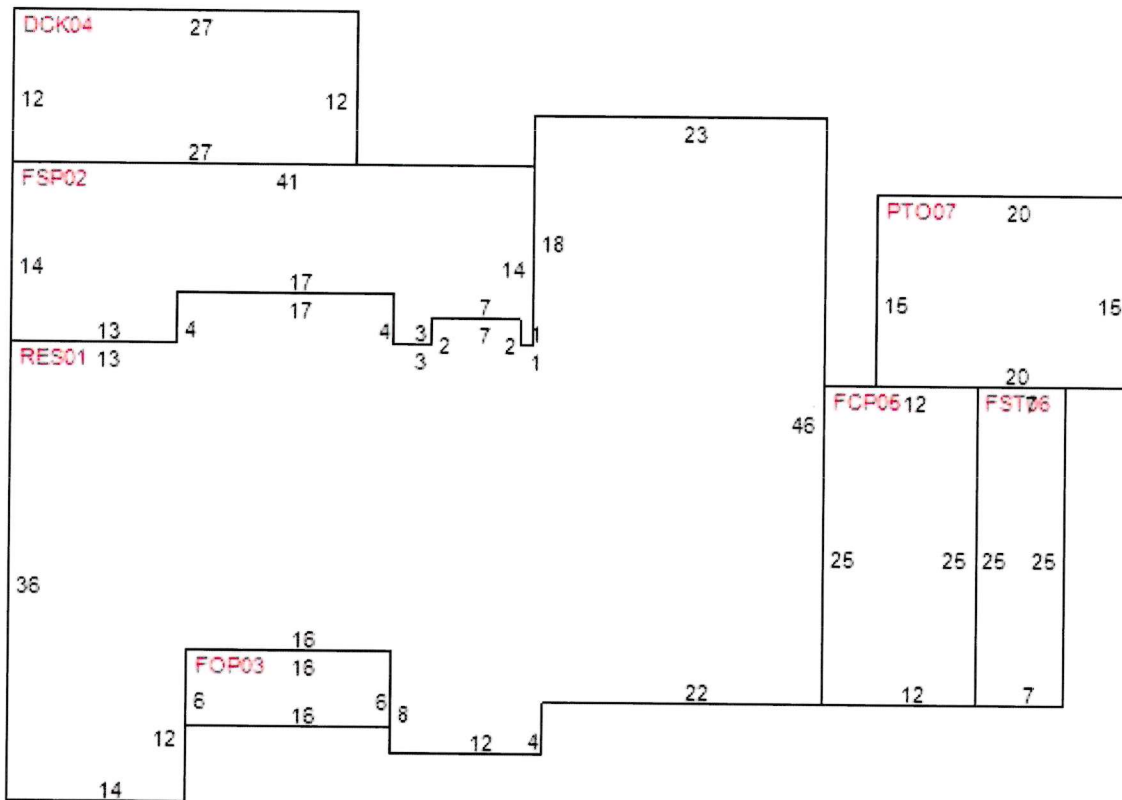

Building Characteristics

Improvement 1F - SFR- 01 FAMILY RESID
Effective Age 3 - 10-14 YRS
Condition 4
Quality Grade 700 - GOOD
Inspected on 9/8/2014 by 187

Year Built 1998
Physical Deterioration 0%
Obsolescence: Functional 0%
Obsolescence: Locational 0%
Architecture 0 - STANDARD SFR
Base Perimeter 264

Type	ID	Exterior Walls	Stories	Year Built	Finished	Attic	Bsmt	Area	Bsmt Finish	Ground Floor Area	Total Flr Area
RES	0132	- CONC BLK-STUCO	1.00	1998	N	0 %	0 %			2,384	2,384
FSP	0201	- NO EXTERIOR	1.00	1998	N	0 %	0 %			492	492
FOP	0301	- NO EXTERIOR	1.00	1998	N	0 %	0 %			96	96
DCK	0401	- NO EXTERIOR	1.00	1998	N	0 %	0 %			324	324
FCP	0501	- NO EXTERIOR	1.00	2008	N	0 %	0 %			300	300
FST	0632	- CONC BLK-STUCO	1.00	2008	N	0 %	0 %			175	175
PTO	0701	- NO EXTERIOR	1.00	2008	N	0 %	0 %			300	300

Section: 1

Roof Style: 10 GABLE
Roof Cover: 08 FBRGLASS SHNGL
Heat Meth 1: 20 HEAT PUMP
Floor Finish: 24 CARPET
Wall Finish: 16 DRYWALL-PAINT
Heat Fuel 1: 10 ELECTRIC
Bedrooms: 3
4 Fixture Baths: 1
3 Fixture Baths: 1
Blt-In Kitchen: Y
Dishwasher: Y
Garbage Disposal: N

Heat Meth 2: 00
Foundation: 7 BLK PERIMETER
A/C: Y

Heat Fuel 2: 00
Fireplaces: 0

2 Fixture Baths: 0
Extra Fixtures: 4
Garbage Compactor: N
Intercom: N
Vacuum: N

Miscellaneous Improvements

Type	Nbr Units	Type	Life	Year In	Grade	Length	Width
159 PAV CONCRETE	578.00	SF	20	1998	3	0.0	0.0
190 SEPTIC 1-5 BTH	1.00	UT	99	1998	2	0.0	0.0
030 DOCK WOOD	772.00	SF	10	1998	2	0.0	0.0
159 PAV CONCRETE	532.00	SF	20	2008	3	0.0	0.0
BTH BOAT HOUSE	288.00	SF	40	2006	2	12.0	24.0

Appraiser Notes

VRBO RENTAL LISTING#321767

Planning and Building

** Permit Search **

Permit Number	Date Issued	Date Completed	Description
2021082001	8/18/2021	9/15/2021	REMOVING SHINGLES AND REPLACING WITH METAL ON AN SFR. FL#72
M120736	12/1/2007	10/1/2008	ADD STORAGE ,ENC GARAGE
MC13018	3/1/1997	2/1/1998	SFR

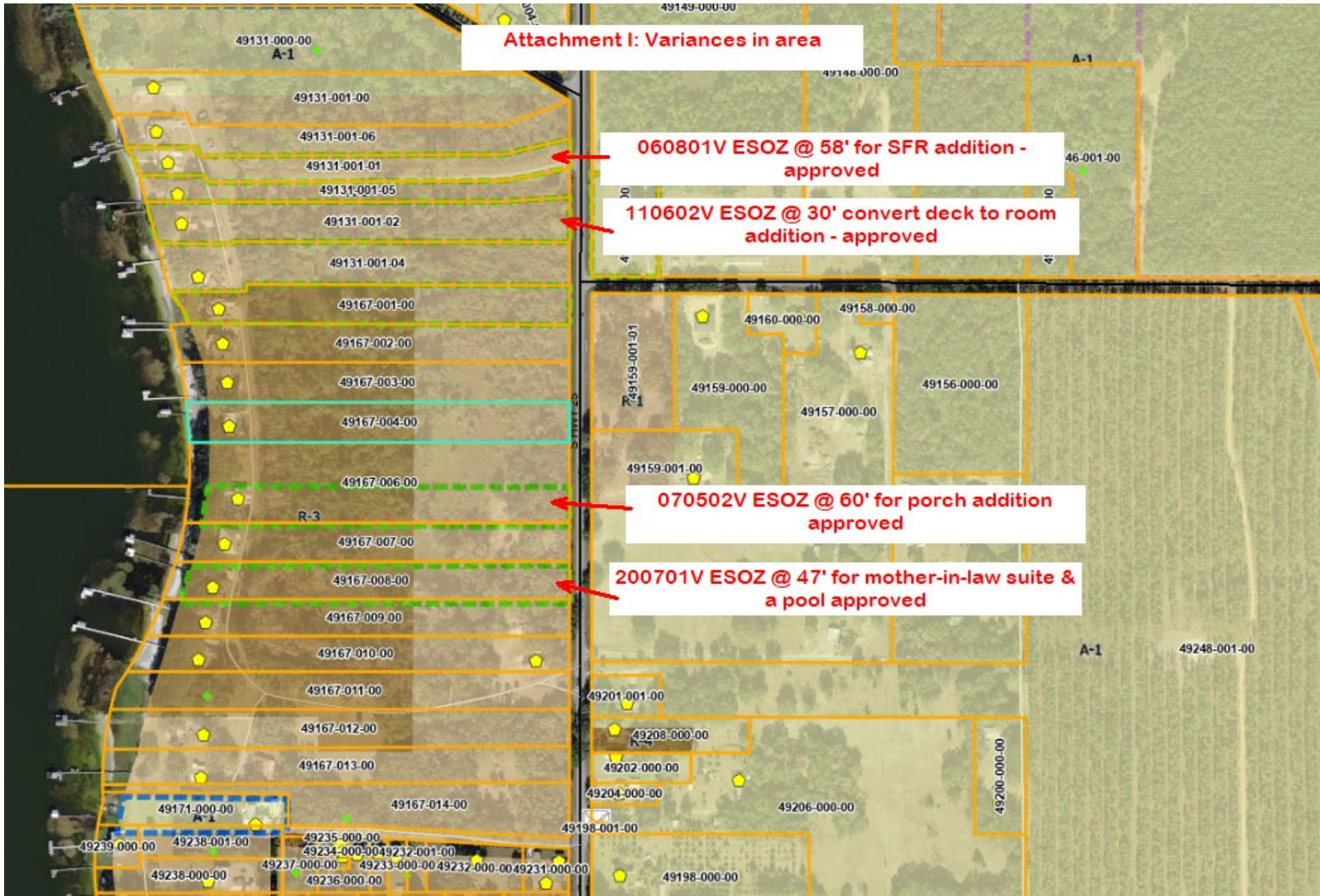



Marion County Board of Adjustment

Agenda Item

File No.: 2024-16380

Agenda Date: 9/9/2024

Agenda No.: 2.2.

SUBJECT:

240805V - Brian and Tamra S. Ahl, Requests Variance, to Reduce the Front Setback from 25' to 19' for Proposed Additional Carport, in a One-and Two-Family Dwelling (R-2) zone, on Parcel Account Number 35322-004-04, Site Address 10030 SW 91st Terrace, Ocala, FL 34481

DESCRIPTION/BACKGROUND:

This is a variance request filed by owners Brian and Tamra Ahl, from the Land Development Code (LDC) Section 4.2.10 E. Structures attached to the home are required to meet the Single-Family Residential (SFR) setbacks and the Land Development Code states that in R-2 zoning, SFR setbacks are 25' from the front property line, 15' from rear property line, and 8' from both side property lines. The applicant is requesting to have a front setback reduction from the required 25' to 19'.



**Marion County
Board of County Commissioners**

Growth Services

2710 E. Silver Springs Blvd.
Ocala, FL 34470
Phone: 352-438-2600
Fax: 352-438-2601

**ZONING SECTION STAFF REPORT
September 9, 2024
BOARD OF ADJUSTMENT PUBLIC HEARING**

Case Number	240805V
CDP-AR	31650
Type of Case	Variance to reduce front setback from 25' to 19' for a second carport to be even with the existing roofline.
Owner/ Applicant	Brian and Tamra Ahl
Street Address	10030 SW 91 ST TER
Parcel Number	35322-004-04
Property Size	.25 acres
Future Land Use	High Density Residential
Zoning Classification	One and Two-Family Dwelling (R-2)
Overlay Zone/Scenic Area	Secondary Springs Protection Overlay Zone (SPOZ), Urban Growth Boundary (UGB)
Project Planner	Rachel Kruger, Zoning Technician I Elizabeth Madeloni, Zoning Technician III
Related Case(s)	N/A

I. ITEM SUMMARY

This is a variance request filed by owners Brian and Tamra Alh, from the Land Development Code (LDC) Section 4.2.10 E. Structures attached to the home are required to meet the Single-Family Residential (SFR) setbacks and the Land Development Code states that in R-2 zoning, SFR setbacks are 25' from the front property line, 15' from rear property line, and 8' from both side property lines. The applicant is requesting to have a front setback reduction from the required 25' to 19'.

FIGURE 1
GENERAL LOCATION MAP



II. PUBLIC NOTICE

Notice of public hearing was mailed to (18) property owners within 300 feet of the subject property on August 23, 2024. A public notice sign was posted on the subject property on August 13, 2024 (Figure 2), and notice of the public hearing was published in the Star-Banner on August 26, 2024. Evidence of the public notice requirements is on file with the Department and is incorporated herein by reference.

III. PROPERTY CHARACTERISTICS

The subject .25-acre lot is located within the recorded subdivision, Pine Run Estates II. The property has a High Residential Future Land Use Map Series (FLUMS) designation with an R-2 Zoning Classification. LDC Section 4.2.10.E provides the determined setbacks to be a minimum 25' front setback, minimum 15' rear setback, and minimum 8' sides setback.

The .25-acre subject property is displayed as Lot 4, Block D, Plat Book V Page 045 in Pine Run Estates II. The property has 100' depth with 107' width. The platted right of way directly along the south side of Lot 4 is 30' wide, 10' of which is the paved road. This does not include a 10' easement along the front of the subject property.

Figure 2
Ahl Property



Figure 3
Right of Way

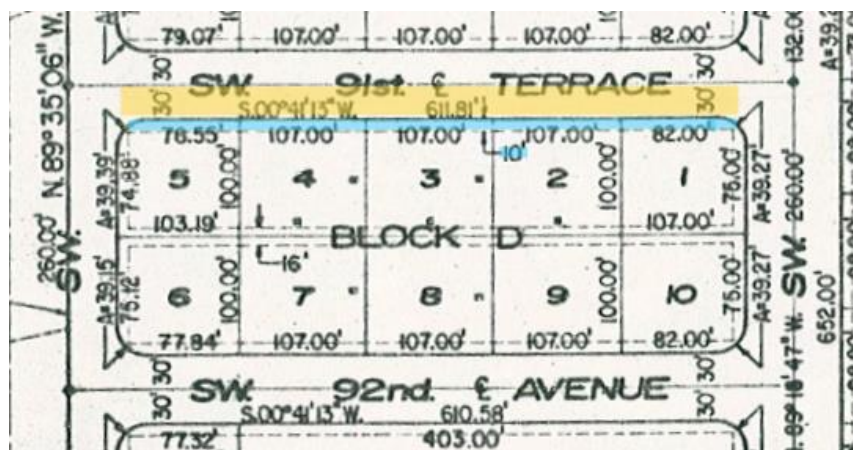

IV. REQUEST STATEMENT

This application requests a variance from LDC Section 4.2.10.E. for the front setback from the required 25' to 19' for an additional carport and new storage structure to be even with the existing carport. Consistent with LDC Section 2.9.3.B., on July 2, 2024, a site visit was conducted by Growth Services Department staff, and measurements and photographs were taken.

**Figure 4
Site Plan**

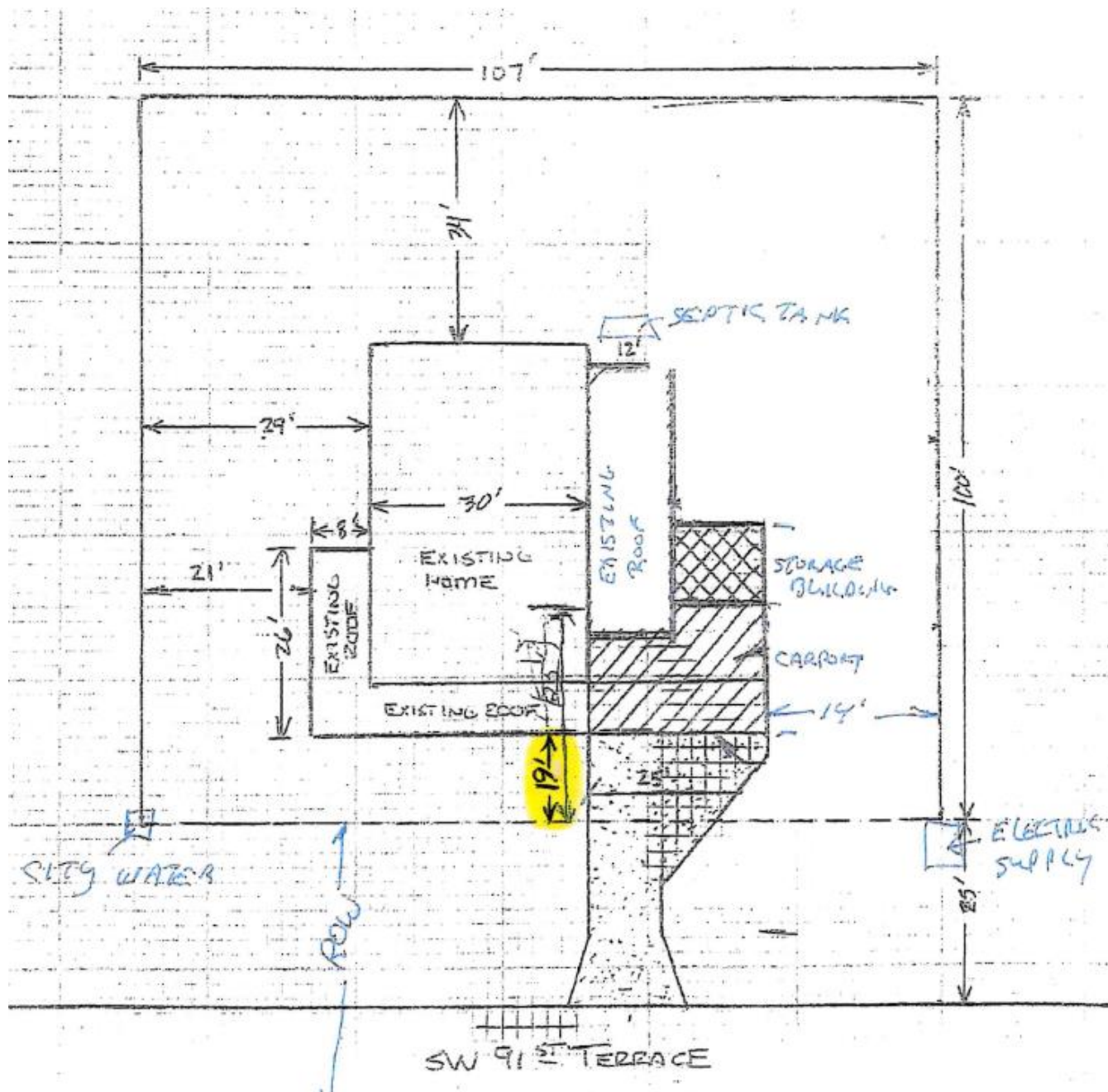

ANALYSIS

LDC Section 2.9.4.E provides the Board of Adjustment shall not grant a variance unless the petition demonstrates compliance with six (6) criteria. The six (6) criteria and the staff's analysis of compliance with those criteria are provided below.

1. Special conditions and circumstances exist which are peculiar to the land, structure, or building involved and which do not apply to other lands, structures, or buildings with the same zoning classification and land use area.

Analysis: Requesting a reduction of the 25' to 19' front setback in an R-2 residential zoning classification to add a second carport. The new structure will be 12' wide and 29' long which will include a storage building at the back of the carport. Adding a carport to the existing building is not possible, nor convenient in any other location.

Staff inspected the property to measure the front setback request and concurs with the above 19' setback request of the applicant, due to the aluminum patio cover extension over existing concrete permit that was approved in 2005.

2. The special conditions and circumstances do not result from the actions of the applicant.

Analysis: There was a previous permit granted and approved for the pouring of the concrete for the new carport. There is only one location to add a new carport. Please see figure 4 which shows the new angle driveway and the 12'x29' pad for a carport and storage building.

Staff finds that the patio cover was permitted in 2005 by different owners and no longer has an available site plan to see the setbacks of that structure. There is a permit that was done in 2023 by the current property owners for the concrete of the new structure. However, the submitted site plan for the concrete permit 2023090396 shows just the dimensions of the new pad and does not show where the proposed carport/storage structure were going on the pad.

3. Literal interpretation of the provisions of applicable regulations would deprive the applicant of rights commonly enjoyed by other properties with the same zoning classification and land use area under the terms of said regulations and would work unnecessary and undue hardship on the applicant.

Analysis: There are over 800 houses in Pine Run, over 80 houses have double carports. Some of the carports were added after the 25' setback was put into place. Granting this variance would fall in line with other granted requests and does not affect any of the neighboring properties.

Staff finds the 30' right of way (ROW) is actually 10' of roadway and the other 20' of ROW is included as part of their front yard like the other neighbors, not including the 10' easement along the front property line. Therefore, all other surrounding

properties in the area have the same conditions and have applied for previous variances, since most of the houses were put in during the 80s’.

4. The variance, if granted, is the minimum variance that will allow the reasonable use of the land, building, or structure.

Analysis: A reduction from the 25’ to 19’ will allow the construction to line up exactly with the current front line of the roof edge. The size of the new structure is the minimum to park a vehicle and have a storage building that will house yard equipment and general household storage.

Staff finds that the 12’ x 29’ carport and storage structure can meet the 25’ setback since the structure is an addition that has not yet been built.

5. Granting the variance requested will not confer on the applicant any special privilege that is denied by these regulations to other lands, buildings, or structures in the same zoning classification and land use area.

Analysis: Granting of this variance will allow the improvements to the property that other property owners in Pine Run have been able to enjoy. The precedent was set back when the setback of 25’ was established after the houses of Pine Run were originally built in 1980’s.

Staff finds granting any variance is a privilege, however, with Pine Run Estates II having the same extended front yard due to the right of way added to everyone’s front yard and the 10’ easement, the variance wouldn’t negatively impact the neighborhood.

6. The granting of the variance will not be injurious to the neighborhood or otherwise detrimental to the public welfare.

Analysis: This does not create any type of safety issue for the neighborhood. It does create a safer structure for the owner’s personal property.

Staff confirms the neighborhood has the same extended right of way merged into their front yards and the variance will not be detrimental to the public welfare.

V. LIST OF ATTACHMENTS

- A. Application – Variance filed by Brian and Tamra Ahl June 10, 2024
- B. Site Plan
- C. Marion County Property Appraiser Property Record Card
- D. 300’ Mailing Radius Map
- E. Area Map of Zoning Classifications
- F. Warranty Deed
- G. Photos



Marion County Board of County Commissioners

Growth Services * Zoning

2710 E. Silver Springs Blvd.
Ocala, FL 34478
Phone: 352-438-2675
Fax: 352-438-2676

*Updated **

OFFICE USE ONLY	
Received By:	_____
Date Received:	_____

VARIANCE APPLICATION

Application #: _____

35322-004-04

FOR COUNTY USE ONLY

Parcel Account Number of Subject Property

THE UNDERSIGNED REQUESTS A VARIANCE AS REFERENCED IN SECTION 2.9 OF THE MARION COUNTY LAND DEVELOPMENT FOR THE PURPOSE OF:

* Adding a second carport structure even with the current front edge of the existing carport.
reduction of 25' to 19' front setback

Section of Code requesting variance from: Sec 4.3.23. Non-conforming Structures

Legal Description (Please attach a copy of deed). Total Acreage of subject property: .25 +/- acres

Directions to subject property:

Enter Pine Run Estates from Highway 200 at SW 88th Ter. Turn left on SW 101st Pl, continue to SW 91 Terrace. Turn right onto SW 91st Ter, 10030 is on left side next to last house.

Please Note: Property owner must sign this application: Otherwise he/she must attach to this application written authorization naming an agent to act in his/her behalf.

Brian A.H. Brian

(Print/Signature) Property Owner

10030 SW 91st Ter

Address

Ocala, FL 34481

City, State, Zip Code

badiver2000@yahoo.com

Contact Info: Phone, cell, e-mail address

TAMRA AHL Tamma All

(Print) Applicant or Agent

10030 SW 91st Ter

Address

Ocala, FL 34481

City, State, Zip Code

Contact Info: Phone, cell, e-mail address

THE FILING FEE IS \$ 550 NON-REFUNDABLE. WE RECOMMEND THAT THE OWNER, APPLICANT OR AGENT BE PRESENT AT THE HEARING. IF NO REPRESENTATIVE IS PRESENT AND THE BOARD REQUIRES ADDITIONAL INFORMATION, THEY MAY DECIDE TO POSTPONE OR DENY THE REQUEST. NOTICE OF SAID HEARING WILL BE MAILED TO THE ABOVE ADDRESS. ALL INFORMATION GIVEN MUST BE CORRECT AND LEGIBLE TO BE PROCESSED. PLEASE NOTE THAT A WRITTEN PETITION (REFER TO PAGE 2 & 3) MUST BE PROVIDED WITH THIS APPLICATION, ALONG WITH A SITE PLAN IN ORDER TO BE CONSIDERED COMPLETE. FOR FURTHER INFORMATION CONTACT THE MARION COUNTY GROWTH SERVICES.

"Meeting Needs by Exceeding Expectations"

WRITTEN PETITION FOR VARIANCE

WRITE YOUR ANSWERS IN THE SPACE PROVIDED AFTER EACH STATEMENT. PLEASE COMPLETE ALL REPLIES USING A SENTENCE FORM. A VARIANCE FROM THE TERMS OF THESE REGULATIONS SHALL NOT BE GRANTED BY THE BOARD OF ADJUSTMENT UNLESS A WRITTEN PETITION FOR A VARIANCE IS SUBMITTED JUSTIFYING THE FOLLOWING:

A. Special conditions and circumstances exist which are peculiar to the land, structure or building involved and which are not applicable to other lands, structures or buildings with the same zoning classification and land use area.

Applicant's justification:

Requesting a reduction of the 25 foot to 19 foot for a front set back in a R-2 Residential zoning classification to add a second carport to the existing carport. The new structure will be 12 feet wide and 29 feet long which will include a storage building at the back of the carport. Adding a carport to the existing building is not possible, nor convenient in any other location.

B. The special conditions and circumstances do not result from the actions of the applicant.

Applicant's justification:

There was a previous permit granted and approved for the pouring of concrete for the new carport. This is the only location to add a new carport. See attached site plan, shows the new angle driveway and the 12 foot by 29 foot pad for carport and storage building.

C. Literal interpretation of the provisions of applicable regulations would deprive the applicant of rights commonly enjoyed by other properties with the same zoning classification and land use are under the terms of said regulations and would work unnecessary and undue hardship on the applicant.

Applicant's justification:

There are over 800 houses in Pine Run. Over 80 houses have double carports. Some of the carports were added after the 25 foot set back was put into place. Granting of this variance would fall in line with other granted requests, and does not affect any of the neighboring properties.

D. The Variance, if granted, is the minimum Variance that will allow the reasonable use of the land, building or structure.

Applicant's justification:

A reduction from 25 feet to 19 feet will allow the construction to line up exactly with the current front line of the roof edge. The size of the new structure is the minimum to park a vehicle and have a storage building that will house yard equipment and general household storage.

E. Granting the Variance requested will not confer on the applicant any special privilege that is denied by these regulations to other lands, buildings or structures in the same zoning classification and land use area.

Applicant's justification:

Granting of this variance will allow the improvements to the property that other property owners in Pine Run and been able to enjoy. The precedent was set back when the set back of 25 feet was established after the houses of Pine Run were originally built in the 1980's.

F. The granting of the Variance will not be injurious to the neighborhood or otherwise detrimental to the public welfare.

Applicant's justification:

This does not create any type of safety issue for the neighborhood. Does create a safer structure for owner's personal property.

To: Kenneth Weyrauch

Marion County Building/Zoning Dept.

From Brian Ahl

10030 SW 91st Ter,

Ocala, FL 34481

Application for Variance Cover Page:

Documents included via Email:

Variance Application

Signature page for Application

Artist Drawing/County print of location

Double Carport House list of Pine Run Estates

Cover Page

5 Documents total.

Pine Run Estates, A 55 + Deed restricted community. Ocala, FL 34481

Double Carport Homes

SW 100th St.

9520, 9680, 9820

SW 95th Ct.

10020

SW100th Pl

9980, 9960, 9821, 9780, 9761, 9378, 9010, 9520, 9261, 9230, 8820

SW 96th Ave

10040

SW 96th Ct

1021

SW 97th Ave

9680, 10060, 10080

SW 90th Ave

10070

SW 91st Ave

10030

SW 101st Ln

9070, 8973, 8934, 8900, 9360, 9570, 9521

SW 102nd Pl

8954, 8972, 9621, 9860, 9940, 9960, 9320, 9215

SW 95th Ave

10151

SW 102nd Ln

9961, 9921

SW 103rd Ln

9950, 9920, 9900, 9165, 9140, 9115, 9010, 8935, 8991

SW 89th Ter

10415, 10355, 10330, 10260

SW 92Nd Ct

10245, 10280, 10330, 10405

SW 104th Ln

9100, 9035, 9015, 9010

SW 104th Pl

9015

SW 89th Ln

8974

SW 87th Ter

10182, 10079, 10078, 10012

SW 88th Ct

10021, 10171

Legend: Street name and then the house numbers on each street.

Jimmy H. Cowan, Jr., CFA

Marion County Property Appraiser



501 SE 25th Avenue, Ocala, FL 34471 Telephone: (352) 368-8300 Fax: (352) 368-8336

2024 Property Record Card Real Estate

35322-004-04

[GOOGLE Street View](#)

Prime Key: 1752329

[Beta MAP IT+](#)

Current as of 6/10/2024

Property Information

AHL BRIAN ✓
AHL TAMRA S ✓
10030 SW 91ST TER
OCALA FL 34481-8925

Taxes / Assessments:

Map ID: 114

Millage: 9002 - UNINCORPORATED

M.S.T.U.

PC: 01

✓ Acres: .25

✓ Situs: Situs: 10030 SW 91ST TER
OCALA

2023 Certified Value

Land Just Value	\$42,000	
Buildings	\$96,333	
Miscellaneous	\$1,262	
Total Just Value	\$139,595	<u>Ex Codes:</u> 01 38
Total Assessed Value	\$139,595	
Exemptions	\$0	
Total Taxable	\$139,595	

History of Assessed Values

Year	Land Just	Building	Misc Value	Mkt/Just	Assessed Val	Exemptions	Taxable Val
2023	\$42,000	\$96,333	\$1,262	\$139,595	\$139,595	\$0	\$139,595
2022	\$36,250	\$71,122	\$994	\$108,366	\$41,319	\$25,000	\$16,319
2021	\$29,000	\$53,339	\$956	\$83,295	\$40,116	\$25,000	\$15,116

Property Transfer History

Book/Page	Date	Instrument	Code	Q/U	V/I	Price
8263/0734	02/2024	05 QUIT CLAIM	0	U	I	\$100
7952/1702	12/2022	07 WARRANTY	4 V-APPRAISERS OPINION	Q	I	\$120,000
7952/1701	12/2022	77 AFFIDAVIT	0	U	I	\$100
7952/1700	12/2022	70 OTHER	0	U	I	\$100
3730/1782	05/2004	07 WARRANTY	2 V-SALES VERIFICATION	Q	I	\$56,000
2284/0200	07/1996	71 DTH CER	0	U	I	\$100
2284/0196	05/1985	74 PROBATE	0	U	I	\$100
1231/0951	07/1984	07 WARRANTY	0	U	I	\$43,900
1151/1119	03/1983	07 WARRANTY	0	Q	I	\$42,000

Property Description

SEC 26 TWP 16 RGE 20 ✓
PLAT BOOK V PAGE 045 ✓
PINE RUN ESTATES II ✓
BLK D LOT 4

Parent Parcel: 35322-000-00

[Land Data - Warning: Verify Zoning](#)

Use	CUse	Front	Depth	Zoning	Units	Type	Rate	Loc	Shp	Phy	Class Value	Just Value
0100		107.0	100.0	R2 ✓	1.00	LT						
Neighborhood 8010 - PINE RUN ESTATES												
Mkt: 7 70												

[Traverse](#)

Building 1 of 1

- RES01=L26D44R26U44.R4D3
- UST02=R8D18L8U18.
- UOP03=D4L4U4R4.L4D29
- UOP04=R12D12L12U12.
- USP05=R12U11L8U14L4D25.D12L26U2
- UEP06=L9U14R9D14.
- UOP07=D2R38D6L47U8R9.

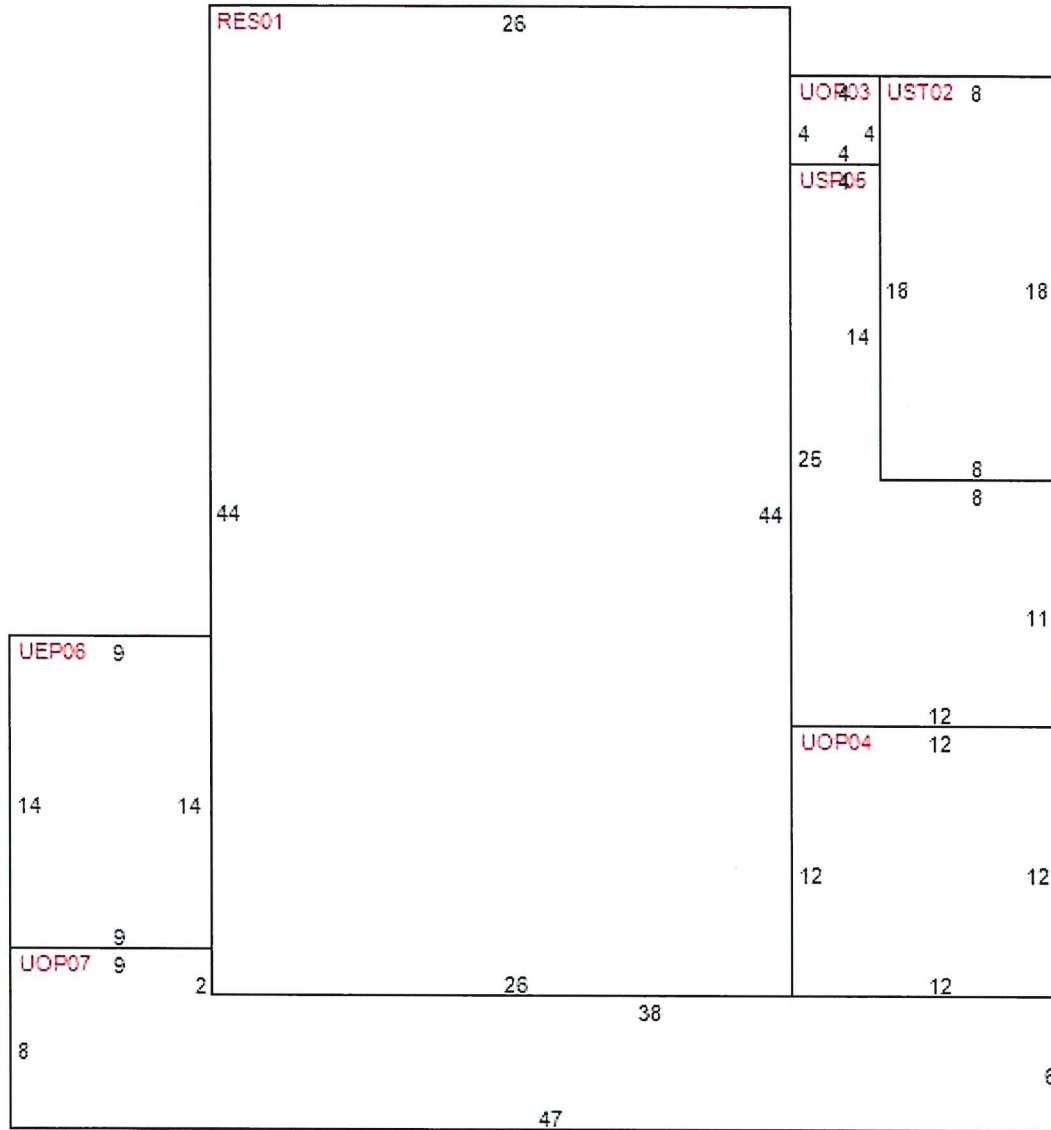

Building Characteristics

Improvement 1F - SFR- 01 FAMILY RESID
Effective Age 5 - 20-24 YRS
Condition 0
Quality Grade 400 - FAIR
Inspected on 1/26/2024 by 197

Year Built 1983
Physical Deterioration 0%
Obsolescence: Functional 0%
Obsolescence: Locational 0%
Architecture 0 - STANDARD SFR
Base Perimeter 140

Type ID	Exterior Walls	Stories	Year Built	Finished Attic	Bsmt Area	Bsmt Finish	Ground Floor Area	Total Flr Area
RES 01	28 - SF ALUM SIDING	1.00	1983	N	0 %	0 %	1,144	1,144
UST 02	28 - SF ALUM SIDING	1.00	1986	N	0 %	0 %	144	144
UOP 03	01 - NO EXTERIOR	1.00	1983	N	0 %	0 %	16	16
UOP 04	01 - NO EXTERIOR	1.00	1983	N	0 %	0 %	144	144
USP 05	01 - NO EXTERIOR	1.00	1983	N	0 %	0 %	188	188
UEP 06	28 - SF ALUM SIDING	1.00	1986	N	0 %	0 %	126	126
UOP 07	01 - NO EXTERIOR	1.00	2005	N	0 %	0 %	300	300

Section: 1

Roof Style: 10 GABLE
Roof Cover: 08 FBRGLASS SHNGL
Heat Meth 1: 20 HEAT PUMP
Floor Finish: 24 CARPET
Wall Finish: 16 DRYWALL-PAINT
Heat Fuel 1: 10 ELECTRIC
Bedrooms: 2
4 Fixture Baths: 0
3 Fixture Baths: 2
Blt-In Kitchen: Y
Dishwasher: Y
Garbage Disposal: N

Heat Meth 2: 00 Heat Fuel 2: 00 2 Fixture Baths: 0 Garbage Compactor: N
 Foundation: 7 BLK PERIMETER Fireplaces: 0 Extra Fixtures: 2 Intercom: N
 A/C: Y Vacuum: N

Miscellaneous Improvements

Type	Nbr Units	Type	Life	Year In	Grade	Length	Width
190 SEPTIC 1-5 BTH	1.00	UT	99	1983	2	0.0	0.0
159 PAV CONCRETE	690.00	SF	20	1983	3	0.0	0.0
159 PAV CONCRETE	492.00	SF	20	2023	3	0.0	0.0

Appraiser Notes

MODEL-UNKNOWN-INT INFO CORRECT

Planning and Building

** Permit Search **

Permit Number	Date Issued	Date Completed	Description
2023090396	9/1/2023	11/7/2023	INSTALL 12X29 CARPORT/SHED PAD (W/FOOTERS) & 12X22 DRIVEWAY
2023042178	4/20/2023	5/9/2023	CHANGE OUT BRYANT 2.5 TON 15.2 SEER2 HEAT PUMP
2023022677	2/23/2023	3/6/2023	SFR MAIN STRUCTURE TEAR OFF SHINGLE AND RE-ROOF SHINGLE FL1
M090611	9/1/2005	11/1/2005	ALUM PTO COVER
M030937	3/1/1999	3/1/1999	RE-ROOF
M010467	1/1/1999	1/1/1999	ALUM ALTERATIONS
MC04269	10/1/1986	-	ADD TO FST
MC01148	3/1/1986	-	ADD FEP
MC00887	3/1/1986	-	ADD FST
MC00255	1/1/1983	3/1/1983	NEW SFR

SITE PLAN

E-2

Front = 25'
Rear = 15'
Side = 8'

AHL RESIDENCE
SCALE: 1:20'

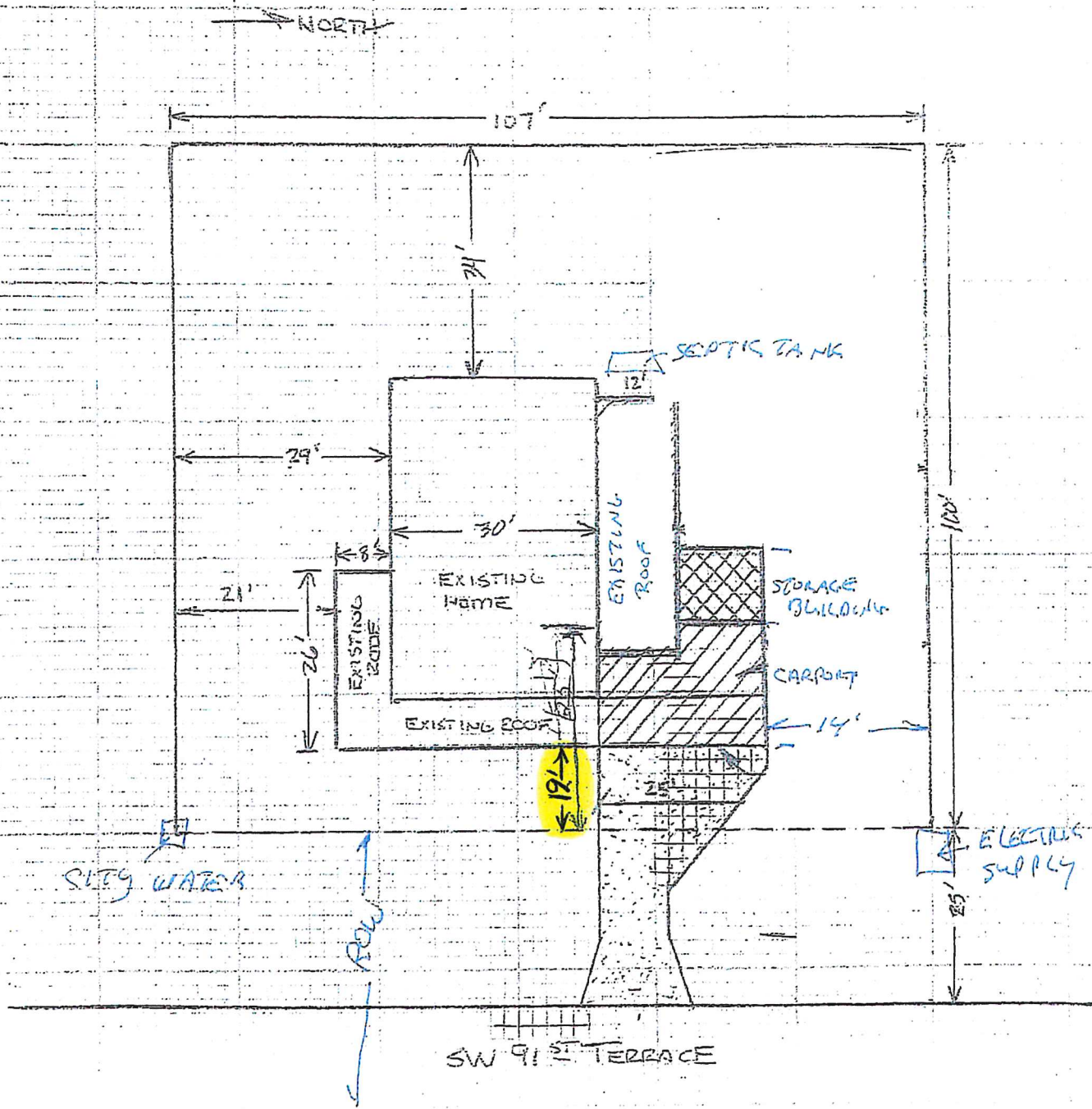

As the owner of the above property, I, BRIAN AHL, certify that the information given above is correct to the best of my knowledge.

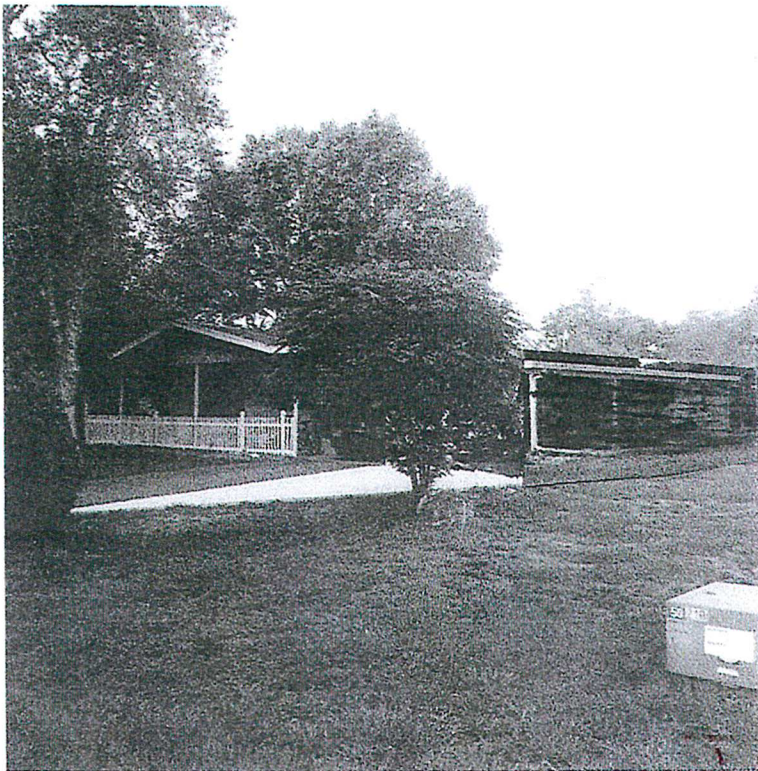

Artist drawing of the finished carport at 10030 91st Terrace, Ocala, Fl.

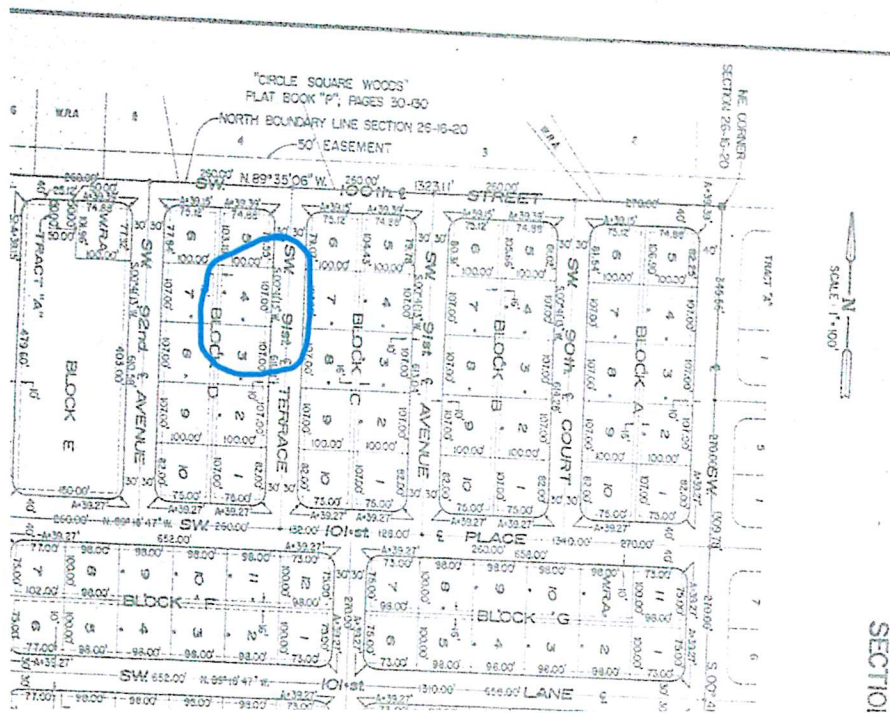

Phase II Pine Run Estates, Ocala, Fl.

MCBCC Interactive Map - Internal



6/10/2024, 11:10:53 AM

1:7.17

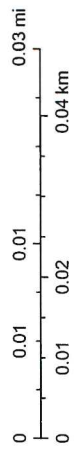

- Parcels Labels
 - Parcels
 - Address Points
 - Structure - Addressed
- County Road Maintenance
 - No Address
 - WRA/DRA
 - Marion County
 - Streets
- Aerial2023
 - Red: Band_1
 - Green: Band_2
 - Blue: Band_3
- OCE Maintained Paved
- Streets

Marion County IT GIS Team, Marion County Property Appraiser, Esri Community Maps Contributors, Marion County Property Appraiser, FDEP, OpenStreetMap, Microsoft, Esri, TomTom, Garmin, SaleGraph, Geotechnologies, Inc, METUNASA, USGS, EPA, NPS,

FOR INTERNAL COUNTY USE ONLY: MAY CONTAIN CONFIDENTIAL INFORMATION. IMPROPER DISCLOSURE MAY RESULT IN CRIMINAL PENALTIES (F.S. 119.10).



Jimmy H. Cowan, Jr., CFA
Marion County Property Appraiser - Beta Map It+

Updated every 24 hrs

View Search Results

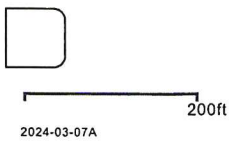
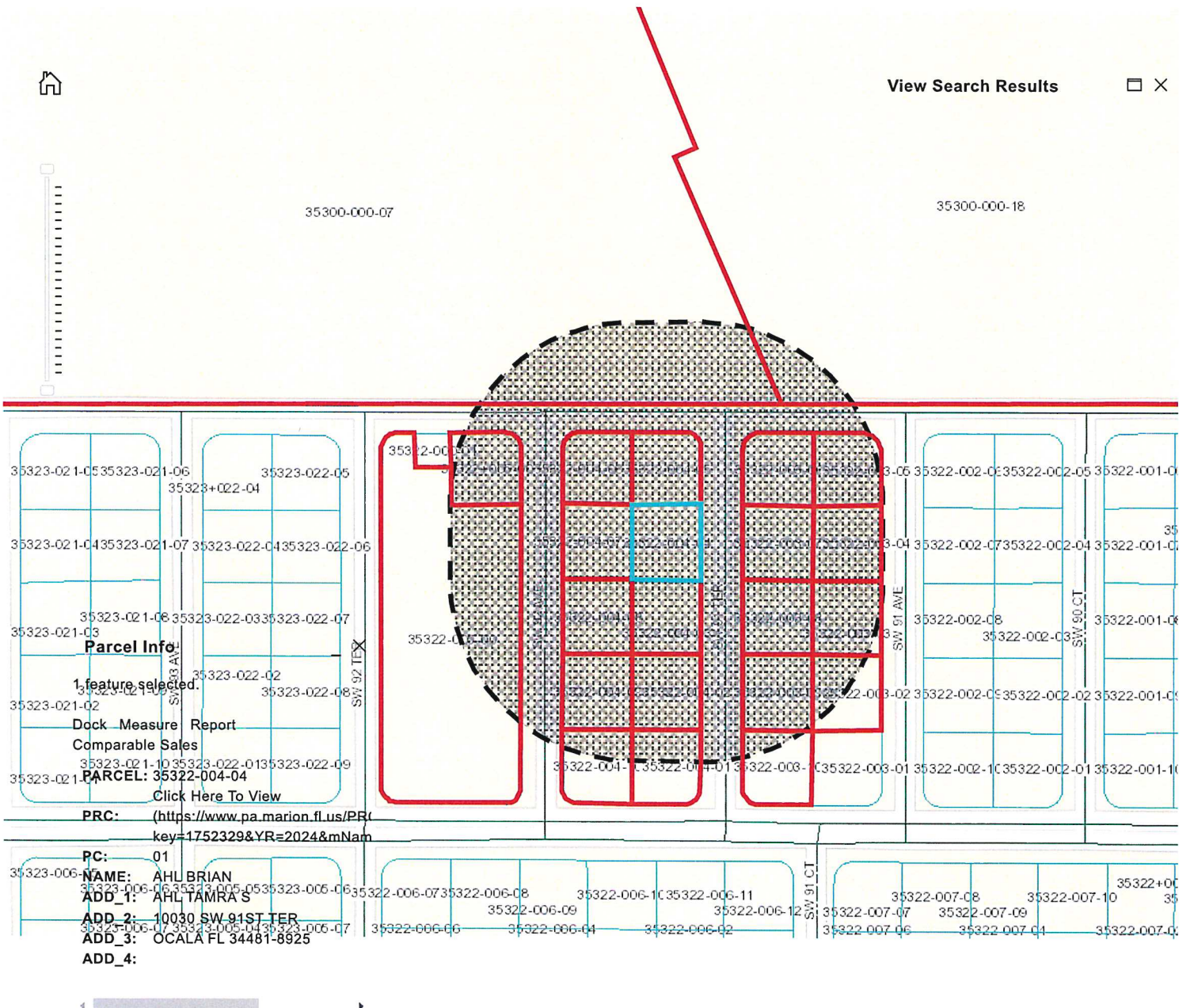

Click here for Legal Disclaimer

NOTARY PUBLIC ACKNOWLEDGEMENT ADDENDUM

SIGNED IN THE PRESENCE OF THE FOLLOWING WITNESSES
TWO SEPARATE DISINTERESTED WITNESSES REQUIRED

Amber Kendall
Witness 1 Signature

Tamara S Ahl Tamra S Ahl
Tamara S Ahl a/k/a Tamra S Ahl

Witness 1 Printed Name and Post Office Address:

Amber Kendall
132 W. Main St
Ashland, OH 44805

Erin Wojcik
Witness 2 Signature

Witness 2 Printed Name and Post Office Address:

Erin Wojcik
132 W Main St
Ashland OH 44805

State of Ohio
County of Ashland

The foregoing instrument was acknowledged before me by means of physical presence or online notarization, this 11th day of February, 2024 by to Tamara S Ahl a/k/a Tamara S Ahl, who has produced Florida Driver License as identification.

Amber Kendall
Notary Public Signature
Printed Name:

My Commission Expires: 07/04/2027
(SEAL)

Online Notary (Check Box if acknowledgment done by Online Notarization)



AMBER KENDALL
NOTARY PUBLIC
STATE OF OHIO
Comm. Expires
07-04-2027

SITE PLAN

E-2

Front = 25'
Rear = 15'
Side = 8'

AHL RESIDENCE
SCALE: 1:20'

Attachment B

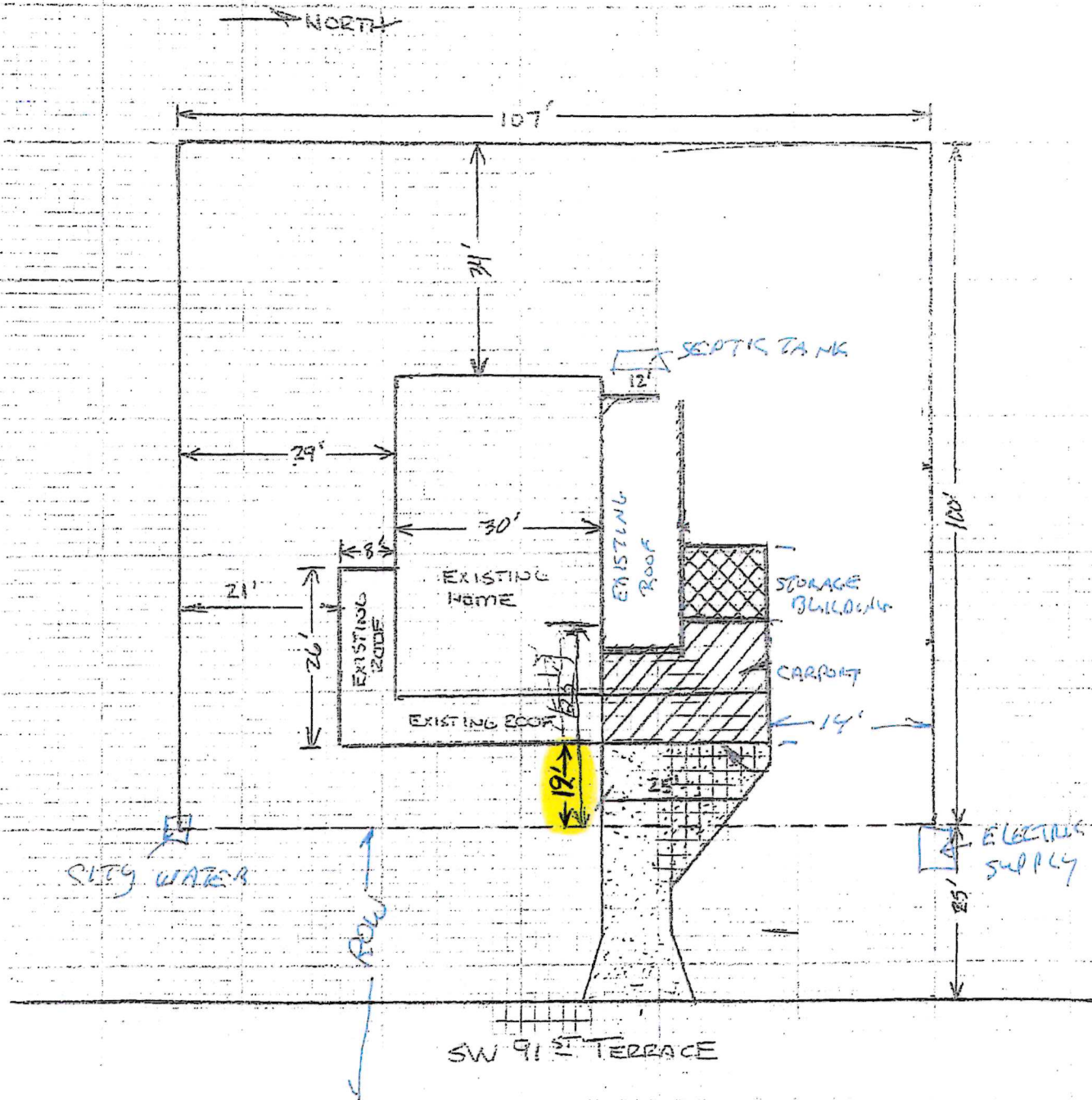

As the owner of the above property, I, BRIAN AHL, certify that the information given above is correct to the best of my knowledge.

Jimmy H. Cowan, Jr., CFA

Marion County Property Appraiser



501 SE 25th Avenue, Ocala, FL 34471 Telephone: (352) 368-8300 Fax: (352) 368-8336

Attachment C

2024 Property Record Card Real Estate

35322-004-04

[GOOGLE Street View](#)

Prime Key: 1752329

[Beta MAP IT+](#)

Current as of 7/10/2024

[Property Information](#)

AHL BRIAN
AHL TAMRA S
10030 SW 91ST TER
OCALA FL 34481-8925

[Taxes / Assessments:](#)

Map ID: 114

[Millage:](#) 9002 - UNINCORPORATED

[M.S.T.U.](#)

PC: 01

Acres: .25

Situs: Situs: 10030 SW 91ST TER OCALA

[2023 Certified Value](#)

Land Just Value	\$42,000	
Buildings	\$96,333	
Miscellaneous	\$1,262	
Total Just Value	\$139,595	Ex Codes: 01 38
Total Assessed Value	\$139,595	
Exemptions	\$0	
Total Taxable	\$139,595	

[History of Assessed Values](#)

Year	Land Just	Building	Misc Value	Mkt/Just	Assessed Val	Exemptions	Taxable Val
2023	\$42,000	\$96,333	\$1,262	\$139,595	\$139,595	\$0	\$139,595
2022	\$36,250	\$71,122	\$994	\$108,366	\$41,319	\$25,000	\$16,319
2021	\$29,000	\$53,339	\$956	\$83,295	\$40,116	\$25,000	\$15,116

[Property Transfer History](#)

Book/Page	Date	Instrument	Code	Q/U	V/I	Price
8263/0734	02/2024	05 QUIT CLAIM	0	U	I	\$100
7952/1702	12/2022	07 WARRANTY	4 V-APPRAISERS OPINION	Q	I	\$120,000
7952/1701	12/2022	77 AFFIDAVIT	0	U	I	\$100
7952/1700	12/2022	70 OTHER	0	U	I	\$100
3730/1782	05/2004	07 WARRANTY	2 V-SALES VERIFICATION	Q	I	\$56,000
2284/0200	07/1996	71 DTH CER	0	U	I	\$100
2284/0196	05/1985	74 PROBATE	0	U	I	\$100
1231/0951	07/1984	07 WARRANTY	0	U	I	\$43,900
1151/1119	03/1983	07 WARRANTY	0	Q	I	\$42,000

[Property Description](#)

SEC 26 TWP 16 RGE 20
PLAT BOOK V PAGE 045
PINE RUN ESTATES II

Parent Parcel: 35322-000-00

[Land Data - Warning: Verify Zoning](#)

Use	CUse	Front	Depth	Zoning	Units	Type	Rate	Loc	Shp	Phy	Class Value	Just Value
0100		107.0	100.0	R2	1.00	LT						
Neighborhood 8010 - PINE RUN ESTATES												
Mkt: 7 70												

[Traverse](#)

Building 1 of 1

- RES01=L26D44R26U44.R4D3
- UST02=R8D18L8U18.
- UOP03=D4L4U4R4.L4D29
- UOP04=R12D12L12U12.
- USP05=R12U11L8U14L4D25.D12L26U2
- UEP06=L9U14R9D14.
- UOP07=D2R38D6L47U8R9.

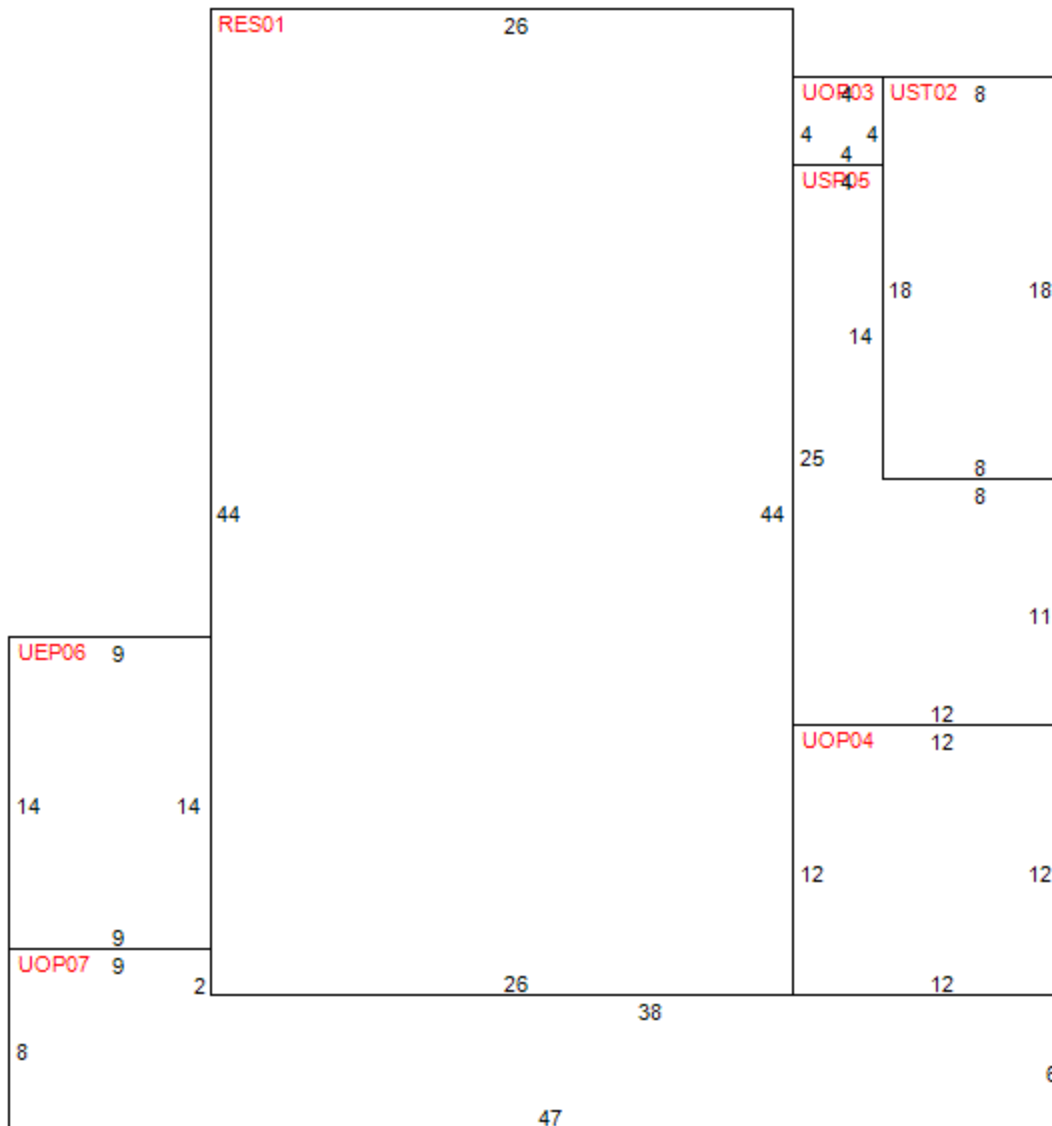

[Building Characteristics](#)

Improvement 1F - SFR- 01 FAMILY RESID
Effective Age 5 - 20-24 YRS
Condition 0
Quality Grade 400 - FAIR
Inspected on 1/26/2024 by 197

Year Built 1983
Physical Deterioration 0%
Obsolescence: Functional 0%
Obsolescence: Locational 0%
Architecture 0 - STANDARD SFR
Base Perimeter 140

Type	ID	Exterior Walls	Stories	Year Built	Finished Attic	Bsmt Area	Bsmt Finish	Ground Floor Area	Total Flr Area
RES	01 28	- SF ALUM SIDING	1.00	1983	N	0 %	0 %	1,144	1,144
UST	02 28	- SF ALUM SIDING	1.00	1986	N	0 %	0 %	144	144
UOP	03 01	- NO EXTERIOR	1.00	1983	N	0 %	0 %	16	16
UOP	04 01	- NO EXTERIOR	1.00	1983	N	0 %	0 %	144	144
USP	05 01	- NO EXTERIOR	1.00	1983	N	0 %	0 %	188	188
UEP	06 28	- SF ALUM SIDING	1.00	1986	N	0 %	0 %	126	126
UOP	07 01	- NO EXTERIOR	1.00	2005	N	0 %	0 %	300	300

Section: 1

Roof Style: 10 GABLE	Floor Finish: 24 CARPET	Bedrooms: 2	Blt-In Kitchen: Y
Roof Cover: 08 FBRGLASS SHNGL	Wall Finish: 16 DRYWALL-PAINT	4 Fixture Baths: 0	Dishwasher: Y
Heat Meth 1: 20 HEAT PUMP	Heat Fuel 1: 10 ELECTRIC	3 Fixture Baths: 2	Garbage Disposal: N
Heat Meth 2: 00	Heat Fuel 2: 00	2 Fixture Baths: 0	Garbage Compactor: N
Foundation: 7 BLK PERIMETER	Fireplaces: 0	Extra Fixtures: 2	Intercom: N
A/C: Y			Vacuum: N

Miscellaneous Improvements

Type	Nbr	Units	Type	Life	Year In	Grade	Length	Width
190 SEPTIC	1.00		UT	99	1983	2	0.0	0.0
159 PAV CONCRETE	690.00		SF	20	1983	3	0.0	0.0
159 PAV CONCRETE	492.00		SF	20	2023	3	0.0	0.0

Appraiser Notes

MODEL-UNKNOWN-INT INFO CORRECT

Planning and Building

**** Permit Search ****

Permit Number	Date Issued	Date Completed	Description
2023090396	9/1/2023	11/7/2023	INSTALL 12X29 CARPORT/SHED PAD (W/FOOTERS) & 12X22 DRIVEWAY
2023042178	4/20/2023	5/9/2023	CHANGE OUT BRYANT 2.5 TON 15.2 SEER2 HEAT PUMP
2023022677	2/23/2023	3/6/2023	SFR MAIN STRUCTURE TEAR OFF SHINGLE AND RE-ROOF SHINGLE FL1
M090611	9/1/2005	11/1/2005	ALUM PTO COVER
M030937	3/1/1999	3/1/1999	RE-ROOF
M010467	1/1/1999	1/1/1999	ALUM ALTERATIONS
MC04269	10/1/1986	-	ADD TO FST
MC01148	3/1/1986	-	ADD FEP
MC00887	3/1/1986	-	ADD FST
MC00255	1/1/1983	3/1/1983	NEW SFR



Jimmy H. Cowan, Jr., CFA
Marion County Property Appraiser - Beta Map It+

Updated every 24 hrs

Attachment D



[View Search Results](#)



35300-000-07

35300-000-18

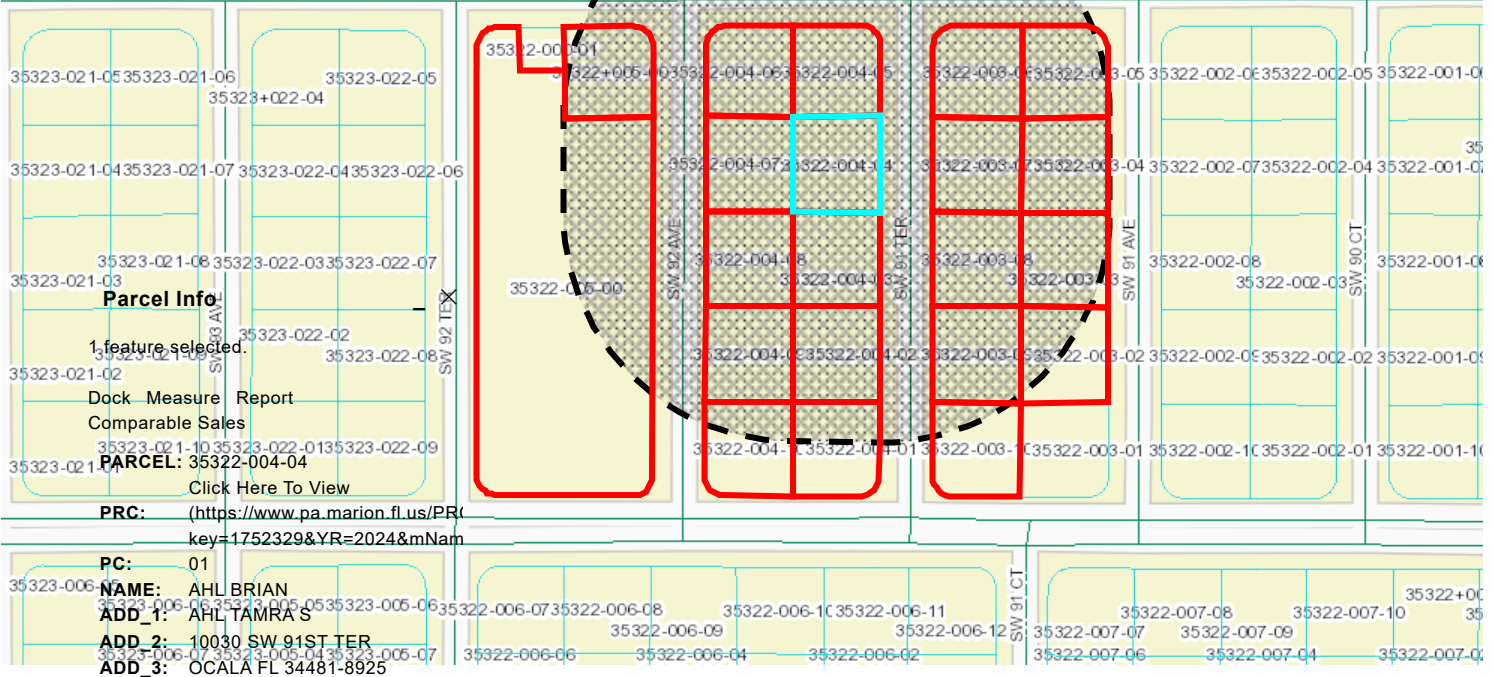

Parcel Info:
 1 feature selected.
 Dock Measure Report
 Comparable Sales
PARCEL: 35322-004-04
 Click Here To View
PRC: (https://www.pa.marion.fl.us/PRC?key=1752329&YR=2024&mNam
PC: 01
NAME: AHL BRIAN
ADD_1: AHL TAMRA S
ADD_2: 10030 SW 91ST TER
ADD_3: OCALA FL 34481-8925
ADD_4:

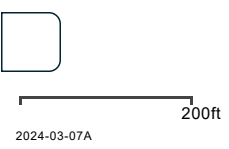

[Click here for Legal Disclaimer](#)

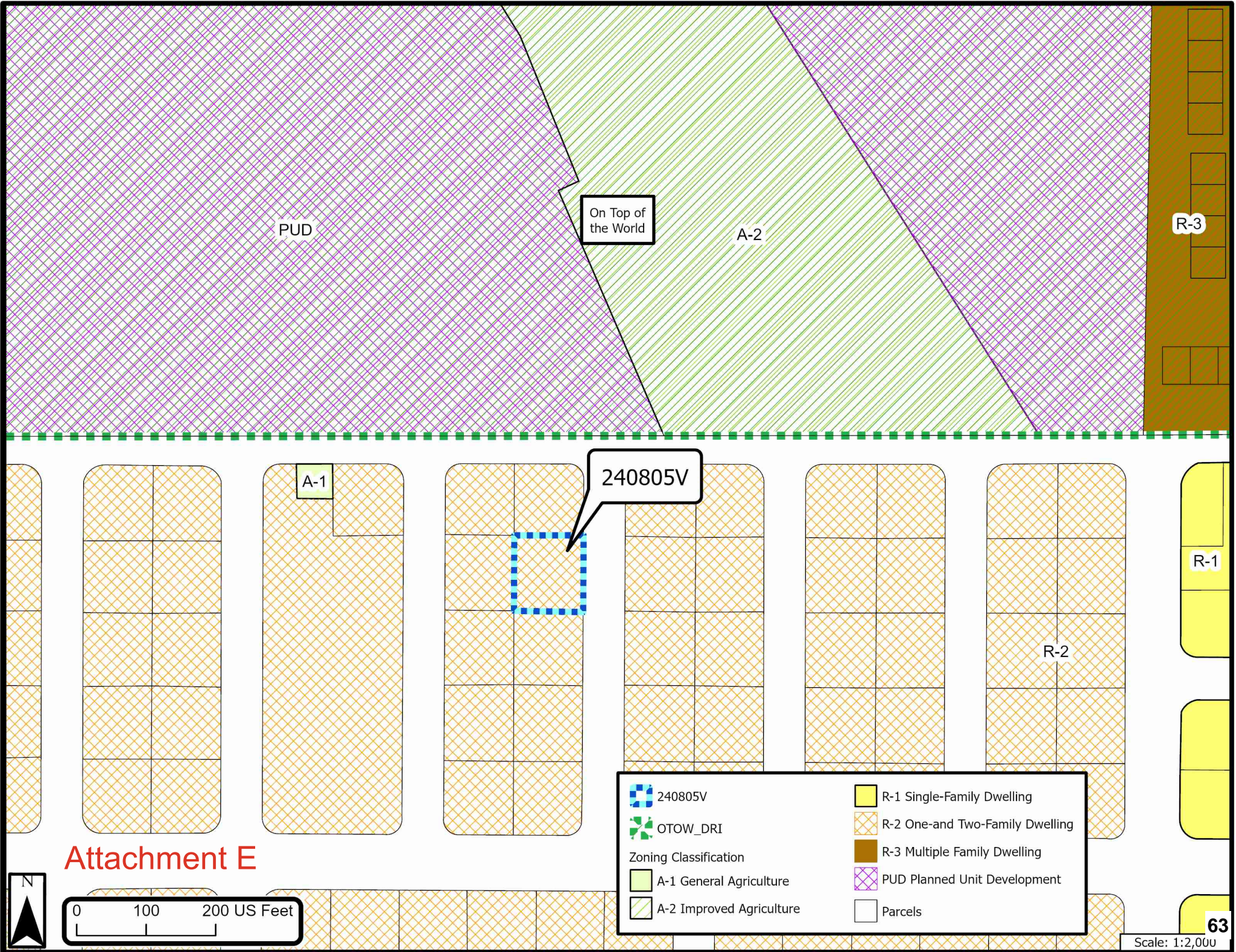

PUD

On Top of the World

A-2

R-3

A-1

240805V

R-1

R-2

Attachment E

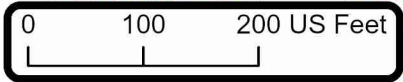

240805V	R-1 Single-Family Dwelling
OTOW_DRI	R-2 One-and Two-Family Dwelling
Zoning Classification	R-3 Multiple Family Dwelling
A-1 General Agriculture	PUD Planned Unit Development
A-2 Improved Agriculture	Parcels

NOTARY PUBLIC ACKNOWLEDGEMENT ADDENDUM

SIGNED IN THE PRESENCE OF THE FOLLOWING WITNESSES
TWO SEPARATE DISINTERESTED WITNESSES REQUIRED

Amber Kendall
Witness 1 Signature

Tamara S Ahl Tamra S Ahl
Tamara S Ahl a/k/a Tamra S Ahl

Witness 1 Printed Name and Post Office Address:

Amber Kendall
132 W. Main St
Ashland, OH 44805

Erin Wojcik
Witness 2 Signature

Witness 2 Printed Name and Post Office Address:

Erin Wojcik
132 W Main St
Ashland OH 44805

State of Ohio
County of Ashland

The foregoing instrument was acknowledged before me by means of physical presence or online notarization, this 11th day of February, 2024 by to Tamara S Ahl a/k/a Tamara S Ahl, who has produced Florida Driver License as identification.

Amber Kendall
Notary Public Signature
Printed Name:

My Commission Expires: 07/04/2027
(SEAL)

Online Notary (Check Box if acknowledgment done by Online Notarization)



AMBER KENDALL
NOTARY PUBLIC
STATE OF OHIO
Comm. Expires
07-04-2027

Attachment G



Close up of concrete slab looking west



Entire existing carport and storage with slab looking Southwest



Facing West looking at the house and new slab



Posted zoning sign (updated after the 08 meeting postponed)



Property looking North



New concrete slab and existing carport with storage looking Southeast



Existing Carport and storage with new concrete looking South



Marion County Board of Adjustment

Agenda Item

File No.: 2024-16381

Agenda Date: 9/9/2024

Agenda No.: 3.1.

SUBJECT:

Update from County Attorney on Shed Permitting

DESCRIPTION/BACKGROUND:

County Attorney, Dana Olesky to give an update on shed permitting.



Marion County Board of Adjustment

Agenda Item

File No.: 2024-16384

Agenda Date: 9/9/2024

Agenda No.: 4.1.

SUBJECT:
July 1, 2024

DESCRIPTION/BACKGROUND:
Previous BOA Meeting Minutes for approval.

MINUTES

MARION COUNTY BOARD OF ADJUSTMENT

July 1, 2024

A public hearing of the Marion County Board of Adjustment was held on July 1, 2024 at 2:00 pm in the Marion County Growth Services Training Room, 2710 E. Silver Springs Boulevard, Ocala, Florida.

The meeting was called to order at 2:05 pm (due to technical difficulties). Members present creating a quorum were: Members C. Cadell Hager, Ernest Hemschot, Thomas Phillips, Nathanael Ramos, Douglas Sherwood; and Alternate Jackie Alsobrook and Samuel Hunt. Staff members present were: County Attorney Dana Olesky, Growth Services Director Chuck Varadin, Deputy Director Kenneth Weyrauch, Staff Assistants IV Darlene A. Pocock and Autumn Williams, along with Zoning Technicians Jeremy Craig, Christina Franco, Rachel Kruger, Lynda Smith and Elizabeth Madeloni.

Thomas Phillips gave the Invocation, followed by Cadell Hager leading the Pledge of Allegiance.

Attorney Dana Olesky explained the procedures for hearing variance requests and Atty. Olesky administered the Oath en masse.

Ken Weyrauch proceeded by reading the provided Affidavit of Publication and the Proof of Required Mailing and Posting of Notice, and advised that the meeting was properly noticed.

- 2.1 **240701V** – James E. and Amanda W. Perry, request a Variance in accordance to Section 2.9 of the Marion County Land Development Code, to reduce the ESOZ front(canal) setback from 75' to 35' for a proposed SFR, in a Single-Family Dwelling (R-1) zone on Parcel Account Number 45824-000-00 addressed as 10843 SE 144th Place, Summerfield, FL 34491.

Rachel Kruger presented the case and read the report into the record and noted the original application was withdrawn and a new application was sent in along with a letter from DEP. Liz Madeloni assisted with the presentation.

There were 11 homeowners notified within 300' of the parcel, with and no letters of opposition nor support received.

Rodney Rogers, 1105 SE 3rd Avenue, Ocala, FL 34471, Engineer doing the ESOZ plan and agent for the owner, stated that looking at the survey the Ordinary High-Water Line is now in the water vs when the land was originally platted in the 1970's. The canal is now further away and wider which will stabilize and slow/stop the erosion. Mr. Rogers noted a biologist went out to the site and mentioned adding a seawall in the future to help prevent any further erosion. Mr. Rogers reiterated the location of the house to the canal was in relation to all the surrounding homes in

the area and that the house size and location meet zoning requirements. He explained the owner did their due diligence by going to DEP and that the only issue is ESOZ.

PUBLIC COMMENT:

There was no one in the audience to speak for, or against, the request and the chair closed the public portion of the hearing.

Ernest Hemschot made a motion to **approve** the variance as requested and moved that, having heard competent substantial evidence, the Board finds that: 1. A special condition or circumstance exists on the property that does not exist on other properties within the same zoning and land use area; 2. The applicant did not cause the special condition or circumstance; 3. Literal enforcement of the regulations would create unnecessary and undue hardship and deprive the applicant of rights commonly enjoyed by other properties within the same zoning and land use area; 4. The variance is the minimal variance that will allow reasonable use of the property; 5. The variance will not confer any special privilege on the applicant that is denied to other properties within the same zoning and land use area; and 6. The granting of the variance will not be injurious to the neighborhood or detrimental to the public welfare; And that the Board grant the variance.

Cadell Hagar made a motion to second.

Motion to Approve - Passed 6 to 1 with Thomas Phillips dissenting.

- 2.2 **240703V** – Robert P. Howes, request a Variance in accordance to Section 2.9 of the Marion County Land Development Code, to reduce the N. side setback from 25’ to 13’ for an existing pergola (trellis type shade structure), in a Light Industrial (M-1) zone on Parcel Account Number 36967-002-00 addressed as 9672 SE 58th Avenue, Belleview, FL 34420.

Lynda Smith presented the case and read the report into the record stating that this request is for the existing unpermitted covered pergola.

There were 7 homeowners notified within 300’ of the parcel, with and no letters of opposition nor support received.

Tim Kirby, 9672 SE 58th Avenue, Ocala, FL 34480, Owner of Flying Boat Tap Room stated this structure started off being used as temporary covered area for customers while waiting on restaurant seating. The idea then grew into this being an outside seating area for customers, which is why the roof was upgraded from the existing tarp like material. Mr. Kirby reiterated that they viewed this as a temporary hurricane proof engineered structure which is why permits weren’t pulled.

PUBLIC COMMENT:

There was no one in the audience to speak for, or against, the request and the chair closed the public portion of the hearing.

Jackie Alsobrook made a motion to **approve** the variance as requested and moved that, having heard competent substantial evidence, the Board finds that: 1. A special condition or circumstance

exists on the property that does not exist on other properties within the same zoning and land use area; 2. The applicant did not cause the special condition or circumstance; 3. Literal enforcement of the regulations would create unnecessary and undue hardship and deprive the applicant of rights commonly enjoyed by other properties within the same zoning and land use area; 4. The variance is the minimal variance that will allow reasonable use of the property; 5. The variance will not confer any special privilege on the applicant that is denied to other properties within the same zoning and land use area; and 6. The granting of the variance will not be injurious to the neighborhood or detrimental to the public welfare; And that the Board grant the variance.

Ernest Hemschot made a motion to second.

Motion to Approve - Passed 7 to 0.

- 2.3 **240704V** – Bradley A. Christopher, request a Variance in accordance to Section 2.9 of the Marion County Land Development Code, to reduce the ESOZ front (canal) setback from 75’ to 45’ for a proposed SFR and from 75’ to 25’ for a proposed pool and patio in a Single-Family Dwelling (R-1) zone on Parcel Account Number 16653-008-08 (un)addressed as 00 NE 303rd Court Road, Salt Springs, FL 32134.

Christina Franco presented the case and read the report into the record and noted the original ESOZ front setback request from 75’ to 42’ for proposed SFR has been updated to reflect a new minimum request from 75’ to 45’. Jeremy Craig assisted with the presentation.

There were 14 homeowners notified within 300’ of the parcel, with and no letters of opposition nor support received.

Applicant not present.

PUBLIC COMMENT:

Sherry Miller, 9800 NE 302 Terrace, Salt Springs, FL 32134, she is not in opposition of applicant request being approved but wanted to comment that she is concerned about the non-paved roads in the area.

The chair closed the public portion of the hearing.

Douglas Sherwood made a motion to **approve** the variance as to ESOZ front (canal) setback from 75’ to 45’ for a proposed SFR only and deny the request for proposed pool and patio setbacks from 75’ to 25’ and moved that, having heard competent substantial evidence, the Board finds that: 1. A special condition or circumstance exists on the property that does not exist on other properties within the same zoning and land use area; 2. The applicant did not cause the special condition or circumstance; 3. Literal enforcement of the regulations would create unnecessary and undue hardship and deprive the applicant of rights commonly enjoyed by other properties within the same zoning and land use area; 4. The variance is the minimal variance that will allow reasonable use of the property; 5. The variance will not confer any special privilege on the applicant that is denied to other properties within the same zoning and land use area; and 6. The granting of the variance will not be injurious to the neighborhood or detrimental to the public welfare; And that the Board grant the variance.

Nathanael Ramos made a motion to second.

Motion to Approve the ESOZ front (canal) setback from 75' to 45' (applicant updated request to the lesser setback) for a proposed SFR ONLY - Passed 6 to 1 with Thomas Phillips dissenting.

Denied request for proposed pool & patio from 75' to 25'.

OTHER BUSINESS:

3.1 Nominations for Vice Chairman

C. Cadell Hagar

APPROVED: 7 to 0

3.2 EAR (Evaluation and Appraisal Report) in regards to QR code and website.

Presented by Ken Weyrauch.

Next BOA hearing scheduled for August 5, 2024.

MINUTES:

The **May 6, 2024** Board of Adjustment Minutes were moved for Approval upon a motion by Cadell Hager with a second by Ernest Hemschot.

Motion for Approval - Passed 7 to 0.

ADJOURNED: The meeting adjourned at 3:35 PM.

Donald M. Barber, Chairman

Attest:

Autumn Williams, Staff Assistant IV